

**NOTES CONT.**

**MATERIALS**

THE SIGN BASE MATERIAL USED FOR THE SIGNS ON THIS SHEET MAY BE ANY OF THE FOLLOWING, WITH MINIMUM THICKNESS AS NOTED.  
 FLAT SHEET ALUMINUM 0.025 INCHES  
 HIGH DENSITY OVERLAYED PLYWOOD 5/8 INCHES

**REFLECTORIZATION**

ALL LEAD SIGNS (W20-1, VC-839) ON THIS SHEET SHALL BE ASTM TYPE VII FLUORESCENT ORANGE SHEETING. ALL OTHER SIGNS ON THIS SHEET SHALL BE ASTM TYPE III RETROREFLECTORIZED SHEETING.

**COLORS**

THE COLORS SHALL CONFORM WITH THE STANDARD COLORS ADOPTED BY AASHTO AND APPROVED BY THE FHWA. COLORS SHOWN ON THIS SHEET CONSIST OF BLACK TEXT AND BORDER ON A RETROREFLECTORIZED ASTM TYPE III OR TYPE VIII ORANGE BACKGROUND.

**INSTALLATION**

THE SIGNS SHALL BE ERECTED BEFORE THE START OF ANY WORK AND SHALL BE COVERED UNTIL WORK COMMENCES, DURING PERIODS OF INACTIVITY, OR UPON COMPLETION OF THE WORK. EACH SIGN SHALL BE ERECTED IN A NEAT AND WORKMANLIKE MANNER ON POSTS SET SECURELY IN THE GROUND. THE BOTTOM OF A SIGN SHALL BE AT LEAST 7 FEET ABOVE THE EDGE OF PAVEMENT, AND THE NEAREST EDGE OF A SIGN SHALL BE AT LEAST 6 FEET OUTSIDE THE SHOULDER POINT, 4 FEET OUTSIDE GUARD RAIL, OR 2 FEET OUTSIDE CURBING, OR SIDEWALK. THE INSTALLATION OF SIGNS SHALL BE SUBJECT TO APPROVAL OF THE ENGINEER. IN URBAN AREAS, THE BOTTOM OF THE SIGN SHALL BE AT LEAST 7 FEET ABOVE THE SIDEWALK. SIGNS MAY BE REMOVED UPON COMPLETION OF THE WORK AT THE DISCRETION OF THE ENGINEER.

**MAINTENANCE**

SIGNS SHALL BE MAINTAINED IN A CLEAN AND LEGIBLE CONDITION SATISFACTORY TO THE ENGINEER. THEY SHALL BE COMPLETELY VISIBLE TO APPROACHING TRAFFIC AT ALL TIMES. THEY SHALL BE KEPT PLUMB AND LEVEL, AND ALWAYS PRESENT A NEAT APPEARANCE. DAMAGED, DEFACED, OR DIRTY SIGNS SHALL BE REPAIRED, CLEANED OR REPLACED AS ORDERED BY THE ENGINEER.

**GENERAL**

THE COST OF FURNISHING, INSTALLING, MAINTAINING AND REMOVING ALL CONSTRUCTION APPROACH SIGNS WILL BE CONSIDERED INCIDENTAL WORK PERTAINING TO THE PROJECT AS A WHOLE AND SHALL BE INCLUDED IN THE CONTRACT UNIT PRICE BID FOR VARIOUS ITEMS INVOLVED IN THE CONTRACT. DURING ALL PHASES OF CONSTRUCTION THE REQUIREMENTS SET FORTH IN THE "MANUAL ON UNIFORM TRAFFIC CONTROL DEVICES" SHALL BE MET.

**SIGN COVERS**

SIGN COVERS SHALL CONSIST OF A PANEL PAINTED FLAT BLACK, THE SAME SIZE AS THE SIGN IT COVERS. THE PANEL SHALL BE OF WOOD, PLYWOOD, HARDBOARD OR ANY MATERIAL SATISFACTORY TO THE ENGINEER. NO MATERIAL WILL BE APPROVED THAT WILL DETERIORATE BY EXPOSURE TO THE WEATHER DURING THE PROJECT. MOUNTING OF THE PANEL SHALL BE DONE IN SUCH A WAY AS NOT TO DAMAGE THE SIGN FACE MATERIAL.

CONTRACTORS SHALL COORDINATE THEIR SIGNING ACTIVITIES WITH OTHER CONTRACTORS WITHIN THE PROJECT LIMITS, AS DIRECTED BY THE REGIONAL CONSTRUCTION ENGINEER.

**SIGN POSTS**

WHERE CONSTRUCTION SIGN INSTALLATIONS ARE NOT PROTECTED BY GUARD RAIL OR OTHER APPROVED TRAFFIC BARRIERS, THE POSTS ON WHICH THE SIGNS ARE MOUNTED SHALL BE YIELDING METAL POSTS, AS DESIGNATED IN THE E SERIES OF STANDARD DRAWINGS OR YIELDING WOODEN POSTS IN ACCORDANCE WITH THE FOLLOWING REQUIREMENTS:

WOODEN POSTS ARE ACCEPTABLE FOR USE WITH CONSTRUCTION SIGNS. THESE POSTS SHALL HAVE A UNIFORM CROSS-SECTION AND SHALL BE MADE FROM GRADE 2, AIR-DRIED SOUTHERN YELLOW PINE OR ANOTHER EQUIVALENT SOFTWOOD. AN ACCEPTABLE EQUIVALENT SOFTWOOD SHALL HAVE AN EXTREME FIBER IN BENDING "Fb" DESIGN VALUE NOT TO EXCEED 1400 PSI AND HORIZONTAL SHEAR "Fv" DESIGN VALUE NOT TO EXCEED 90 PSI SPECIFICATION; "DESIGN VALUES FOR WOOD CONSTRUCTION" AND RELATED SUPPLEMENT, LATEST EDITION.

AS ESTABLISHED BY THE NATIONAL FOREST PRODUCTS ASSOCIATION IN THEIR NATIONAL DESIGN THE FOLLOWING ARE CONSIDERED TO BE ACCEPTABLE WOODEN POSTS:

1. 4" X 4" (ACTUAL DIMENSIONS ARE S4S 3.5" X 3.5")
    - A) ACCEPTABLE FOR SINGLE OR DUAL POSTS INSTALLATION WITH NO MODIFICATIONS.
- ALL WOODEN POSTS SHALL HAVE AN EMBEDMENT DEPTH OF 4 FEET. NO CROSS-BRACING OR BACK-BRACING TO KEEP THE POSTS PLUMB WILL BE ALLOWED. CONCRETE FOUNDATIONS COLLARS OR SOIL BEARING PLATES ARE NOT PERMITTED. CONSTRUCTION SIGNS SHALL BE PLACED ON TWO OR MORE POSTS WHEN ANY OF THE FOLLOWING CONDITIONS GOVERN:
- A) THE SIGN WIDTH (HORIZONTAL DIMENSIONS FOR DIAMOND SHAPED SIGNS) EXCEEDS 3 1/2 FEET.
  - B) THE EXPOSED SIGN AREA OF ANY SINGLE SIGN OR ASSEMBLY EXCEEDS 7 SQ. FEET.
  - C) THE Sv OF A SINGLE POST IS 64

**OTHER STDS. E-100, E-101, E-102 REQUIRED:**

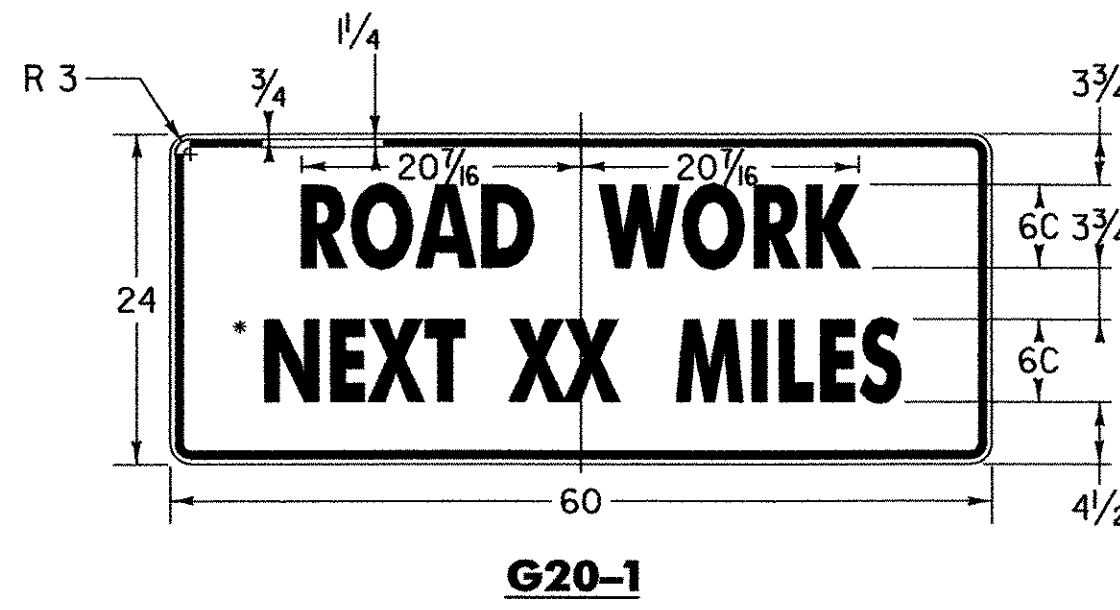
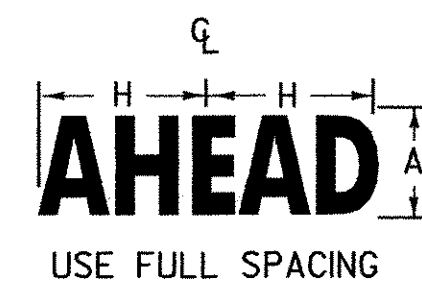
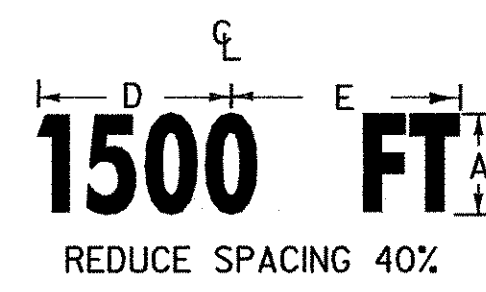
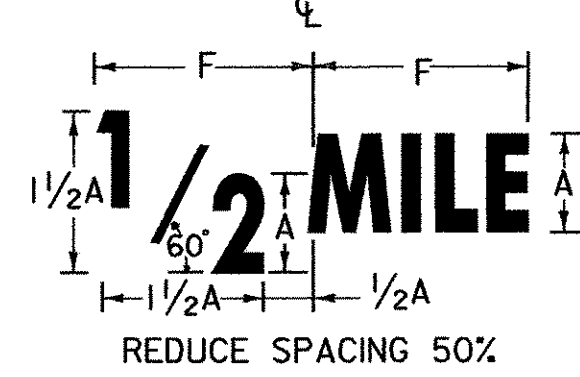
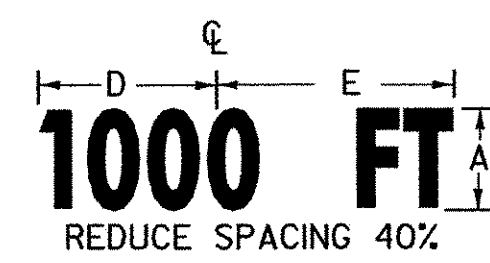
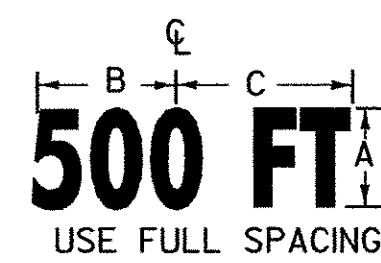
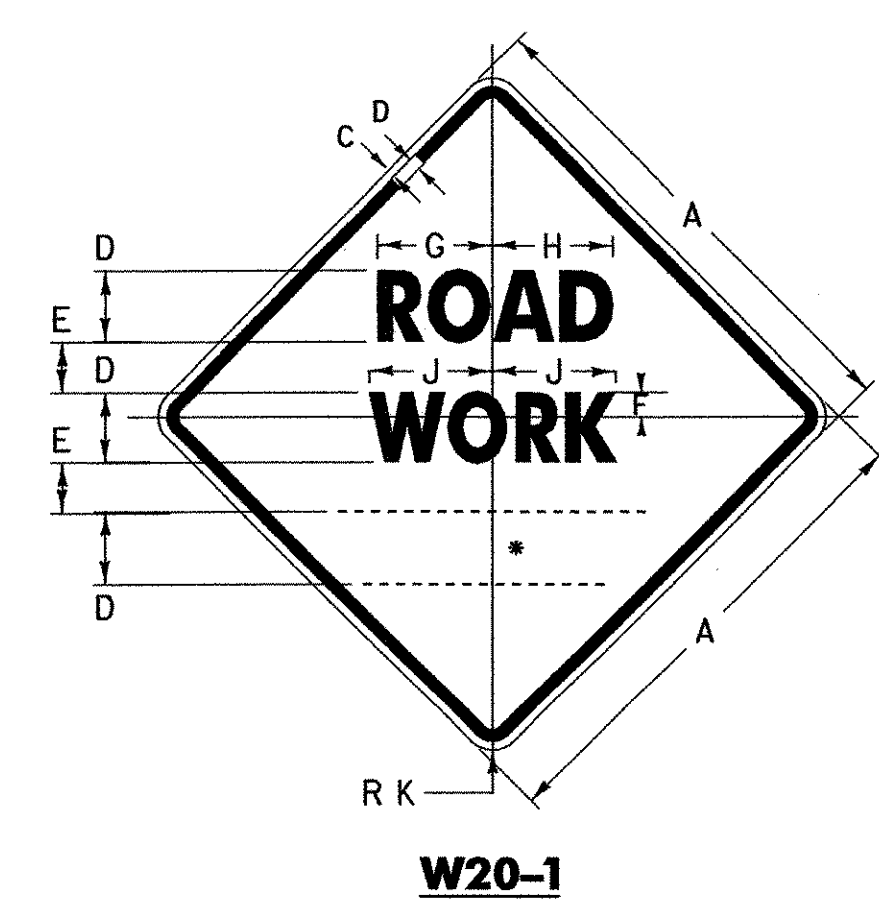

THIS SIGN TO BE USED WHEN PROJECT LENGTH EXCEEDS 2 MILES OR AS REQUESTED BY THE RESIDENT ENGINEER. SHOW MILEAGE TO NEAREST 1/4 MILE USING FRACTIONS, NOT DECIMALS. HAND LETTERING OF MILEAGE WILL NOT BE ALLOWED.

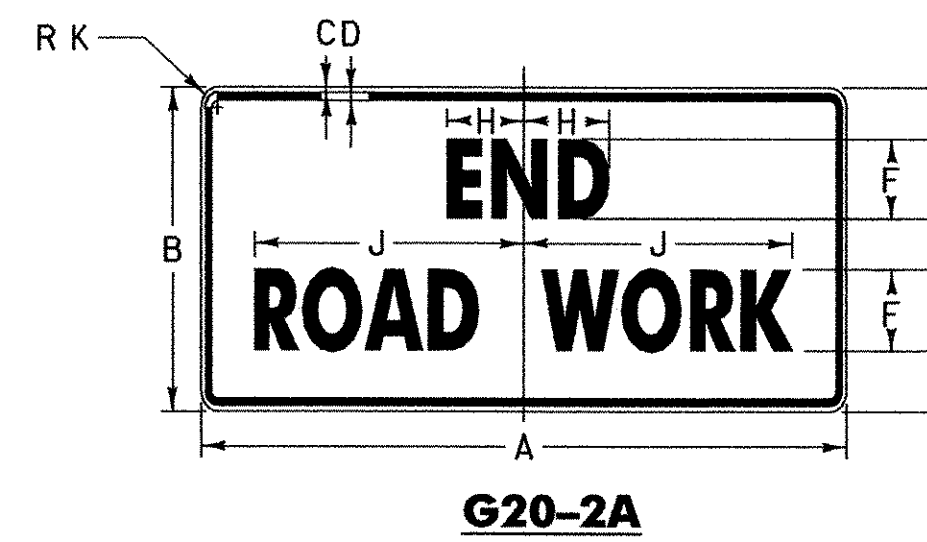

| SIGN | DIMENSIONS (INCHES) |    |     |       |       |    |       |       |        |       |
|------|---------------------|----|-----|-------|-------|----|-------|-------|--------|-------|
|      | A                   | B  | C   | D     | E     | F  | G     | H     | J      | K     |
| MIN. | 36                  | 18 | 5/8 | 7/8   | 3 3/4 | 4C | 2 1/2 | 4     | 12 5/8 | 2 1/4 |
| STD. | 48                  | 24 | 3/4 | 1 1/4 | 4 1/8 | 6C | 3 3/4 | 5 7/8 | 22     | 3     |

| SIGN | DIMENSIONS (INCHES) |     |       |    |       |       |        |        |        |       |
|------|---------------------|-----|-------|----|-------|-------|--------|--------|--------|-------|
|      | A                   | B   | C     | D  | E     | F     | G      | H      | J      | K     |
| MIN. | 36                  | 5/8 | 7/8   | 5D | 3 1/2 | 3 1/4 | 8 3/8  | 8 7/8  | 9      | 2 1/4 |
| STD. | 48                  | 3/4 | 1 1/4 | 7D | 4 3/4 | 4 1/2 | 11 1/8 | 12 7/8 | 12 5/8 | 3     |

| DIMENSIONS (INCHES) |        |        |        |        |        |        |        |
|---------------------|--------|--------|--------|--------|--------|--------|--------|
| A                   | B      | C      | D      | E      | F      | G      | H      |
| 5D                  | 10 3/8 | 10 3/8 | 11 5/8 | 11 1/4 | 11 1/4 | 9 1/2  | 10 7/8 |
| 7D                  | 14 1/4 | 15 1/8 | 14 7/8 | 15 3/4 | 15 3/4 | 13 1/8 | 15 1/2 |

(ALL DIMENSIONS SHOWN IN INCHES)

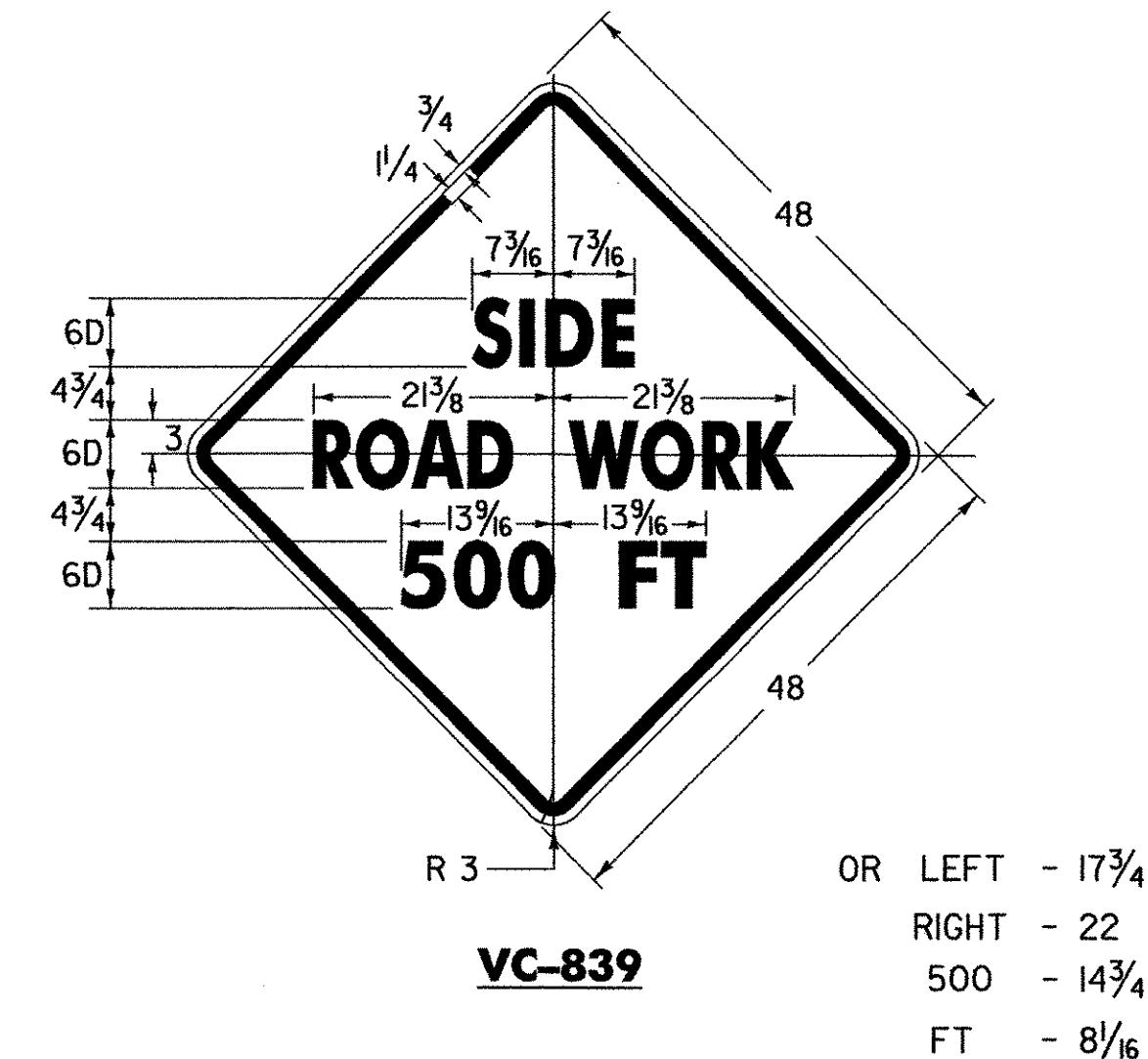

**NOTES**

THE SIGNS SHOWN ON THIS SHEET ARE INTENDED FOR USE IN PROVIDING ADVANCE WARNING AND INFORMATION ON CONSTRUCTION PROJECTS OVER WHICH TRAFFIC WILL BE MAINTAINED. WHEN ADDITIONAL APPROACH SIGNS OR OTHER TYPES OF ADVANCE SIGNING OR CONTROL ARE NECESSARY, THE PLANS AND/OR THE SPECIFICATIONS FOR THAT PROJECT WILL GIVE THE DETAILS OF THE SIGNS AND DEVICES REQUIRED. FOR ON-PROJECT CONSTRUCTION SIGNS, REFER TO APPROPRIATE STANDARD SHEETS.

**APPLICATION OF STANDARDS**

SINCE IT IS NOT POSSIBLE TO PRESCRIBE DETAILED STANDARDS OF APPLICATION FOR ALL OF THE SITUATIONS THAT MAY CONCEIVABLY ARISE ON A CONSTRUCTION PROJECT, REFERENCE SHALL BE MADE TO THE "MANUAL ON UNIFORM TRAFFIC CONTROL DEVICES" FOR THE PRINCIPLES, PROCEDURES, AND STANDARDS THAT WILL BE REQUIRED IN CONNECTION WITH ADVANCED WARNING AND ON-PROJECT CONSTRUCTION SIGNS AND BARRICADES. THE SIGNS SHOWN IN E-101 AND E-102 REPRESENT A SAMPLE OF THOSE MORE COMMONLY USED.

**LOCATION**

THE SIGNS SHALL BE LOCATED AS DETAILED ON THIS SHEET OR AS OTHERWISE SHOWN ON THE PLANS. THEY SHALL APPEAR AT EACH END OF THE HIGHWAY UNDER CONSTRUCTION AND ON ALL INTERSECTING PUBLIC HIGHWAYS. THE ENGINEER SHALL DETERMINE THE EXACT LOCATIONS.

**DESIGN**

LETTERS, DIGITS, ARROWS SPACING AND TEXT DIMENSIONS SHALL CONFORM WITH THE "STANDARD HIGHWAY SIGNS BOOK" AND DESIGNS PRESCRIBED IN THE MANUAL ON UNIFORM TRAFFIC CONTROL DEVICES (MUTCD) ADOPTED BY THE U.S. DEPARTMENT OF TRANSPORTATION, FEDERAL HIGHWAY ADMINISTRATION (FHWA).

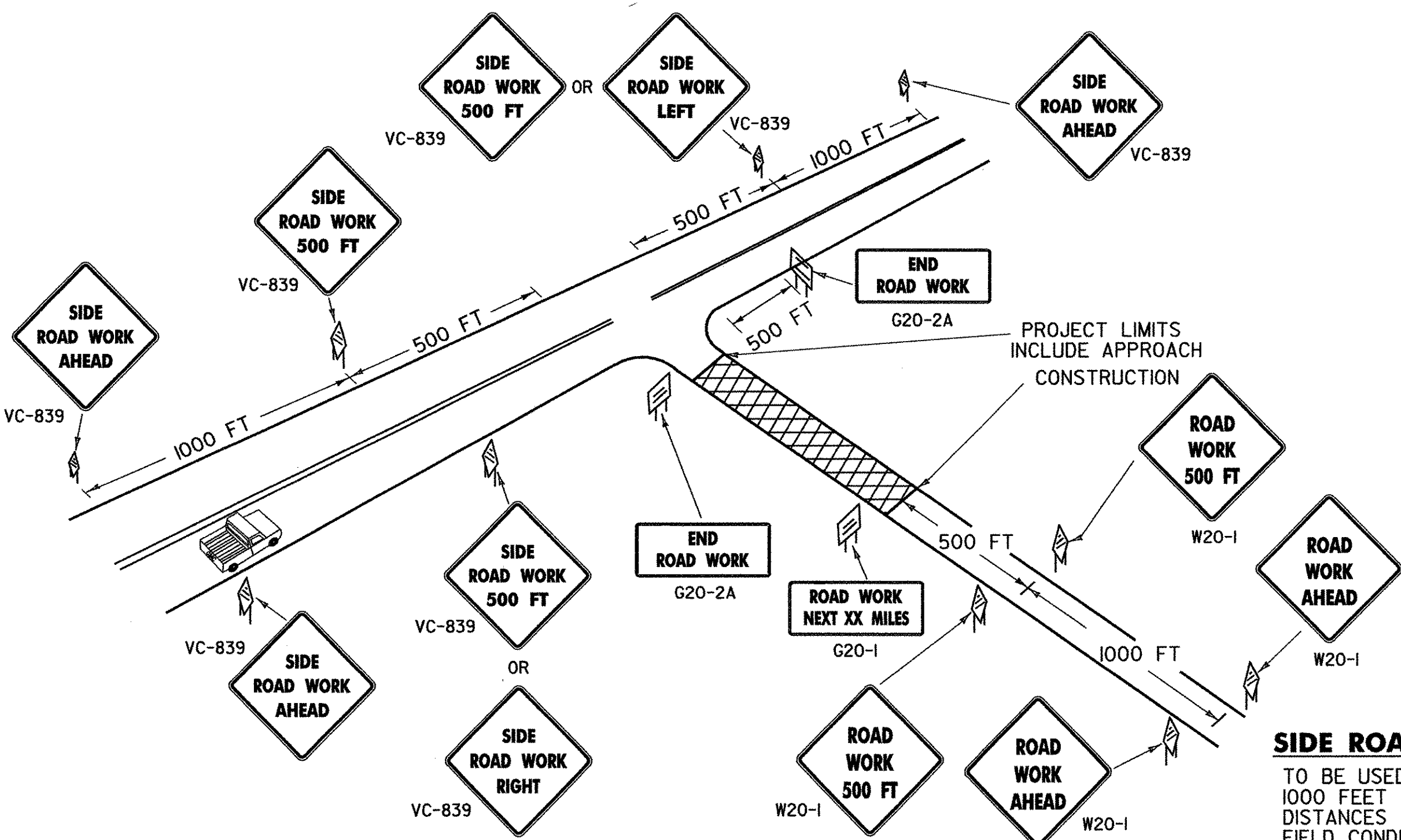

**SIDE ROAD APPROACH SIGNING**

TO BE USED WHEN CONSTRUCTION IS UP TO 1000 FEET FROM THE INTERSECTION. ALL DISTANCES ARE DESIRABLE MINIMUMS. FIELD CONDITIONS SHALL CONTROL THE ACTUAL PLACEMENT.  
 ALL W20-1 AND VC-839 SIGNS SHALL BE ASTM TYPE VIII FLUORESCENT ORANGE SHEETING.

REVISIONS AND CORRECTIONS  
 JAN. 06, 1997 - DATE OF ORIGINAL ISSUE  
 JAN. 2, 2004 - CHANGED REFLECTIVE SHEETING TO ASTM TYPE III OR TYPE VIII

APPROVED  
  
 DIRECTOR OF PROGRAM DEVELOPMENT  
  
 TRAFFIC OPERATIONS ENGINEER  
  
 FEDERAL HIGHWAY ADMINISTRATION

SIDE ROAD CONSTRUCTION APPROACH SIGNS

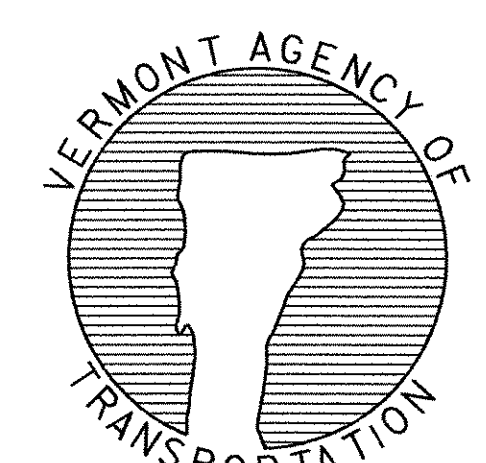

STANDARD E-100A