

VAOT RURAL AREA MIX					
% WEIGHT	LBS/AC		NAME	GERM %	PURITY %
	BROADCAST	HYDROSEED			
37.5%	22.5	45	CREEPING RED FESCUE	85%	98%
37.5%	22.5	45	TALL FESCUE	90%	95%
5.0%	3	6	RED TOP	90%	95%
15.0%	9	18	BIRDSFOOT TREFOIL	85%	98%
5.0%	3	6	ANNUAL RYE GRASS	85%	95%
100%	60	120			

VAOT URBAN AREA MIX					
% WEIGHT	LBS/AC		NAME	GERM %	PURITY %
	BROADCAST	HYDROSEED			
42.5%	34	68	CREEPING RED FESCUE	85%	98%
10.0%	8	16	PERENNIAL RYE GRASS	90%	95%
42.5%	34	68	KENTUCKY BLUE GRASS	85%	85%
5.0%	4	8	ANNUAL RYE GRASS	85%	95%
100%	80	160			

SOIL AMENDMENT GUIDANCE			
FERTILIZER		LIME	
BROADCAST	HYDROSEED	BROADCAST	HYDROSEED
10-20-10	<i>FOLLOW</i>	PELLETIZED	<i>FOLLOW</i>
500 LBS/AC	<i>MANUFACTURER</i>	2 TONS/AC	<i>MANUFACTURER</i>

### CONSTRUCTION GUIDANCE

1. RURAL SEED MIX: USE AS INDICATED IN THE PLANS AND/OR FOR ALL ESTABLISHED UPLAND (NON WETLAND) AREAS DISTURBED BY THE CONTRACTOR.
2. URBAN SEED MIX: USE AS INDICATED IN THE PLANS AND/OR FOR ALL ESTABLISHED LAWN AREAS DISTURBED BY THE CONTRACTOR.
3. ALL SEED MIXTURES: SHALL NOT HAVE A WEED CONTENT EXCEEDING 0.40% BY WEIGHT AND SHALL BE FREE OF ALL NOXIOUS SEED.
4. FERTILIZER AND LIMESTONE: SHALL FOLLOW RATES SHOWN ON PLAN OR AS DIRECTED BY THE ENGINEER
5. HAY MULCH: TO BE PLACED ON EARTH SLOPES AT THE RATE OF 2 TONS/ACRE, ACHIEVE 90% GROUND COVER OR AS DIRECTED BY THE ENGINEER.
6. TOPSOIL: TO BE USED WITH SEED AS INDICATED ON THE PLANS, OR AS DIRECTED BY THE ENGINEER.
7. HYDROSEEDING: ALTHOUGH GUIDANCE IS GIVEN ABOVE THE SITE CONDITIONS AND THE TYPE OF HYDROSEED WILL ULTIMATELY DICTATE THE AMOUNTS AND TYPES OF SOIL AMENDMENTS TO BE APPLIED
8. TURF ESTABLISHMENT: PLACING SEED, FERTILIZER, LIME AND MULCH PRIOR TO SEPTEMBER 15 AND AFTER APRIL 15 CAN BETTER ENSURE A VIGOROUS GROWTH OF GRASS.

ADAPTED FROM VTRANS TECHNICAL LANDSCAPE MAUAL FOR ROADWAYS AND TRANSPORTATION FACILITIES

### TURF ESTABLISHMENT

#### REVISIONS

JUNE 23, 2009	WHF
JANUARY 15, 2010	WHF
FEBRUARY 16, 2011	WHF

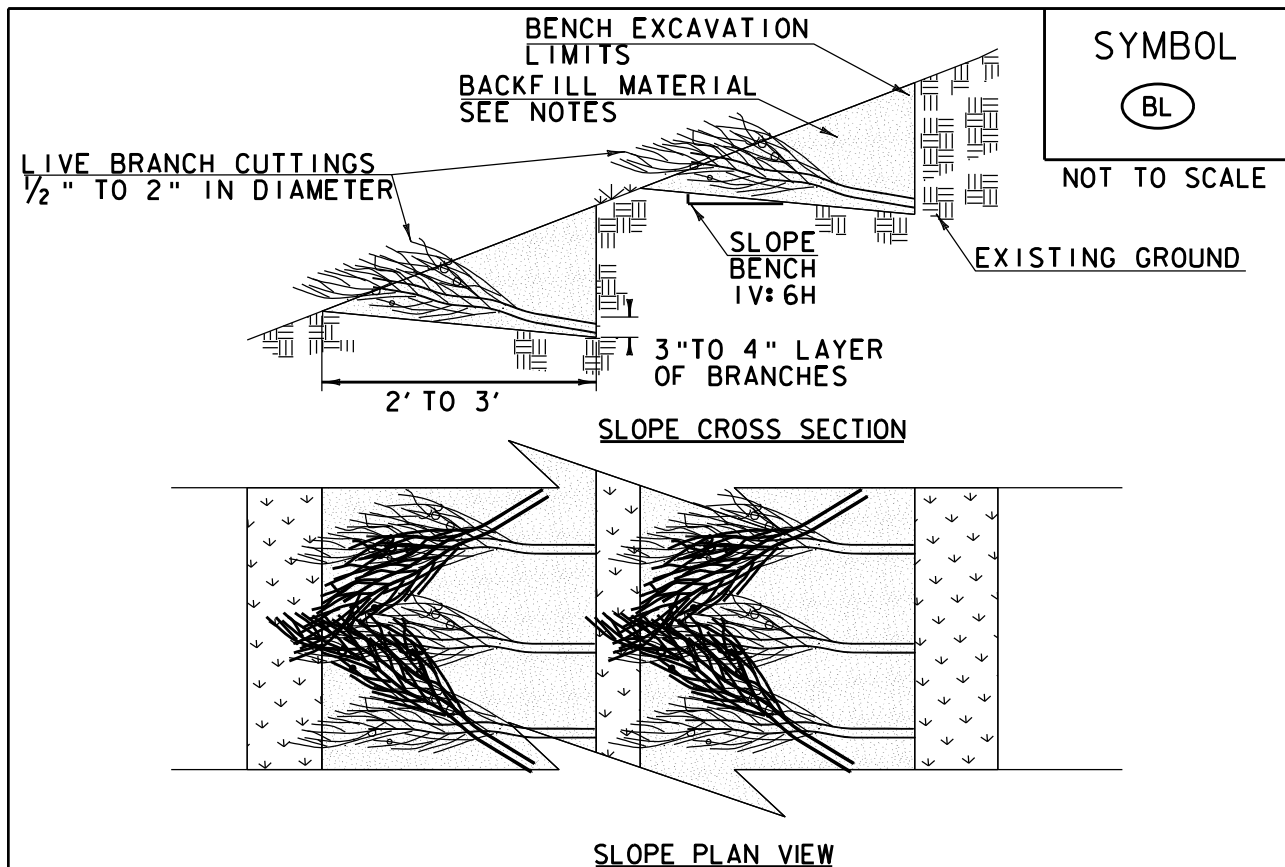

SYMBOL  
 (BL)

NOT TO SCALE

CONSTRUCTION SPECIFICATIONS

1. BENCH SHALL BE ANGLED SO OUTSIDE EDGE IS HIGHER THAN BACK OF BENCH.
2. LIVE BRANCH CUTTINGS SHALL BE PLACED ON THE BENCH IN A CRISSCROSS OR OVERLAP CONFIGURATION, 3" TO 4" THICK.
3. GROWING TIPS SHALL BE ALIGNED OUT OF THE SLOPE FACE AND SHALL EXTEND SLIGHTLY BEYOND THE FILL AREA.
4. FILL EACH LOWER BENCH WITH SOIL EXCAVATED FROM THE BENCH ABOVE. TOP BENCH TO BE BACKFILLED WITH INITIAL EXCAVATION.
5. PLACE BACKFILL ON TOP OF BRANCHES AND HAND TAMP IN 6" LIFTS TO REDUCE AIR POCKETS.
6. SEED OR OTHER EROSION CONTROL MATERIAL SHALL BE USED BETWEEN THE ROWS AS STATED IN THE CONTRACT DOCUMENTS.
7. BRUSH LAYER BENCHES SHALL BE FROM 3' TO 5' VERTICAL APART. DEPENDING ON SLOPE, AS SHOWN ON PLANS MEASURED BETWEEN FRONT EDGE OF BENCHES.

ADAPTED FROM DETAILS PROVIDED BY: NEW YORK STATE DEC  
 ORIGINALLY DEVELOPED BY USDA-NRCS  
 VERMONT DEPARTMENT OF ENVIRONMENTAL CONSERVATION

BRUSH LAYER

**NOTES:**

REFER TO "THE VERMONT STANDARDS & SPECIFICATIONS FOR EROSION PREVENTION & SEDIMENT CONTROL -2006- " FROM THE VT AGENCY OF NATURAL RESOURCES FOR ADDITIONAL GUIDANCE.

THIS WORK SHALL BE PERFORMED IN ACCORDANCE WITH SECTION 653 FOR BRUSH LAYERING (PAY ITEM 653.75) OR AS SPECIFIED IN THE CONTRACT.

**REVISIONS**

MARCH 7, 2008	WHF
JANUARY 28, 2009	WHF

SYMBOL



NOT TO SCALE

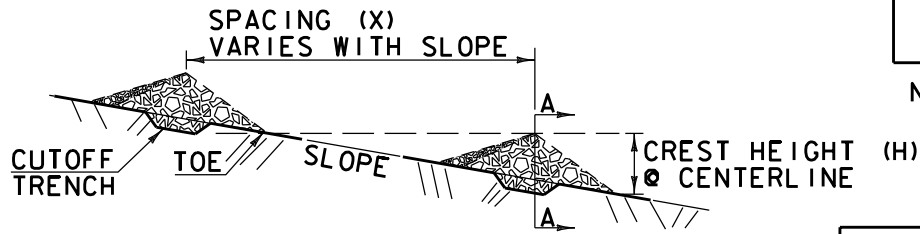

PROFILE

$$X = \frac{H (ft)}{\text{SLOPE } (ft/ft)}$$

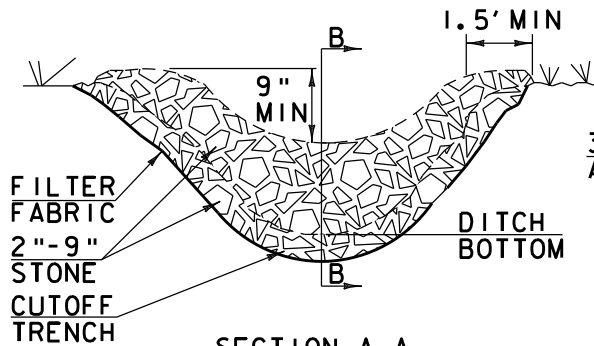

SECTION A-A

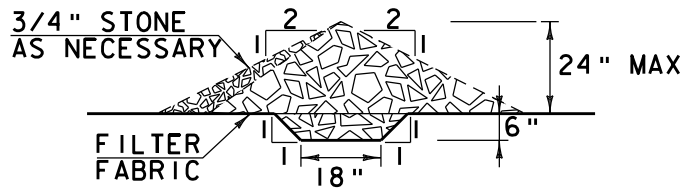

SECTION B-B

CONSTRUCTION SPECIFICATIONS

1. STONE WILL BE PLACED ON A FILTER FABRIC FOUNDATION.
2. CHECK DAMS SHALL BE SPACED SO THAT THE ELEVATION OF THE CREST OF THE DOWNSTREAM DAM IS AT THE SAME ELEVATION AS THE TOE OF THE UPSTREAM DAM.
3. 3/4" FILTERING STONE MAY BE ADDED TO THE FACE OF THE CHECK DAM AS NECESSARY.
4. EXTEND THE STONE A MINIMUM OF 1.5' BEYOND THE DITCH BANKS TO PREVENT CUTTING AROUND THE DAM.
5. PROTECT CHANNEL DOWNSTREAM OF THE LOWEST CHECK DAM FROM SCOUR AND EROSION WITH STONE OR LINER AS APPROPRIATE.
6. ENSURE THAT CHANNEL APPURTENANCES SUCH AS CULVERT ENTRANCES BELOW CHECK DAMS ARE NOT SUBJECT TO DAMAGE OR BLOCKAGE FROM DISPLACED STONE.
7. MAXIMUM DRAINAGE AREA 2 ACRES.

ADAPTED FROM DETAILS PROVIDED BY: NEW YORK STATE DEC  
 ORIGINALLY DEVELOPED BY USDA-NRCS  
 VERMONT DEPARTMENT OF ENVIRONMENTAL CONSERVATION

CHECK DAM

NOTES:

REFER TO "THE VERMONT STANDARDS & SPECIFICATIONS FOR EROSION PREVENTION & SEDIMENT CONTROL -2006- " FROM THE VT AGENCY OF NATURAL RESOURCES FOR ADDITIONAL GUIDANCE.

THIS WORK SHALL BE PERFORMED IN ACCORDANCE WITH SECTION 653 FOR TEMPORARY STONE CHECK DAM, TYPE I(PAY ITEM 653.25)

REVISIONS

MARCH 21, 2008	WHF
JANUARY 8, 2009	WHF

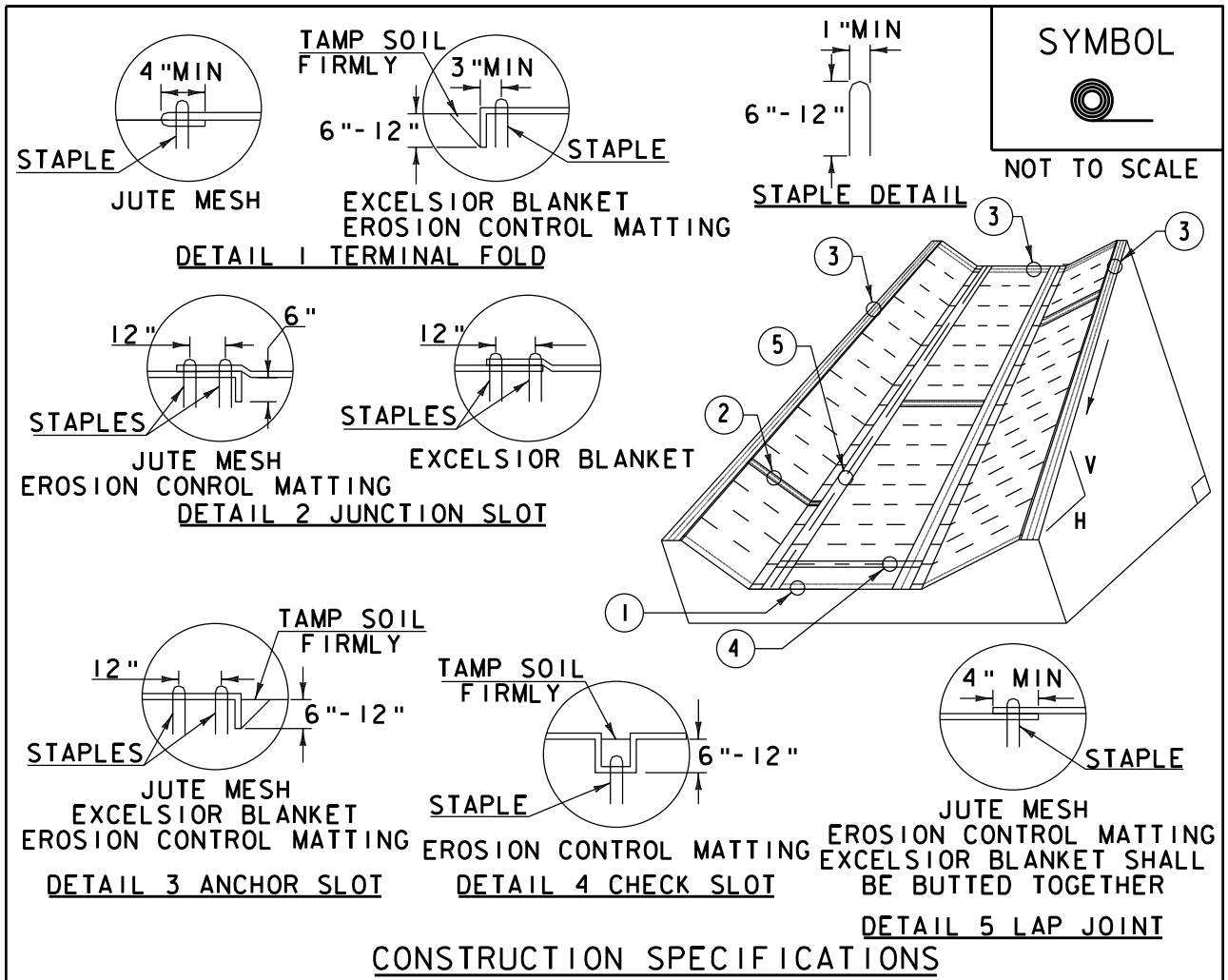

**CONSTRUCTION SPECIFICATIONS**

1. EROSION MATTING, CHECK SLOTS, SHALL BE SPACED IN DITCH CHANNEL SO THAT ONE OCCURS WITHIN EACH 50' ON SLOPES OF MORE THAN 4% AND LESS THAN 6%. ON SLOPES OF 6% OR MORE, THEY SHALL BE SPACED SO THAT ONE OCCURS WITHIN EACH 25'.
2. APPLY FERTILIZER, LIME SEED PRIOR TO PLACING MATTING.
3. STAPLES ARE TO BE PLACED ALTERNATELY, IN COLUMNS APPROXIMATELY 2' APART AND IN ROWS APPROXIMATELY 3' APART. APPROXIMATELY 175 STAPLES ARE REQUIRED PER 4' X225' ROLL OF MATERIAL AND 125 STAPLES ARE REQUIRED PER 4' X150' ROLL OF MATERIAL.
4. DISTURBED AREAS SHALL BE SMOOTHLY GRADED. EROSION CONTROL MATERIAL SHALL BE PLACED LOOSELY OVER GROUND SURFACE. DO NOT STRETCH.
5. ALL TERMINAL ENDS AND TRANSVERSE LAPS SHALL BE STAPLED AT APPROXIMATELY 12" INTERVALS.

ADAPTED FROM DETAILS PROVIDED BY: NEW YORK STATE DEC  
 ORIGINALLY DEVELOPED BY USDA-NRCS  
 VERMONT DEPARTMENT OF ENVIRONMENTAL CONSERVATION

**ROLLED EROSION  
 CONTROL PRODUCT  
 (RECP) DITCH**

**NOTES:**  
 REFER TO "THE VERMONT STANDARDS & SPECIFICATIONS FOR EROSION PREVENTION & SEDIMENT CONTROL -2006-" FROM THE VT AGENCY OF NATURAL RESOURCES FOR ADDITIONAL GUIDANCE.  
 THIS WORK SHALL BE PERFORMED IN ACCORDANCE WITH SECTION 653 AND AS SHOWN IN THE PLANS FOR TEMPORARY EROSION MATTING (PAY ITEM 653.20) OR PERMANENT EROSION MATTING (PAY ITEM 653.21).

REVISIONS	
MARCH 8, 2007	JMF
APRIL 16, 2007	WHF
JANUARY 13, 2009	WHF

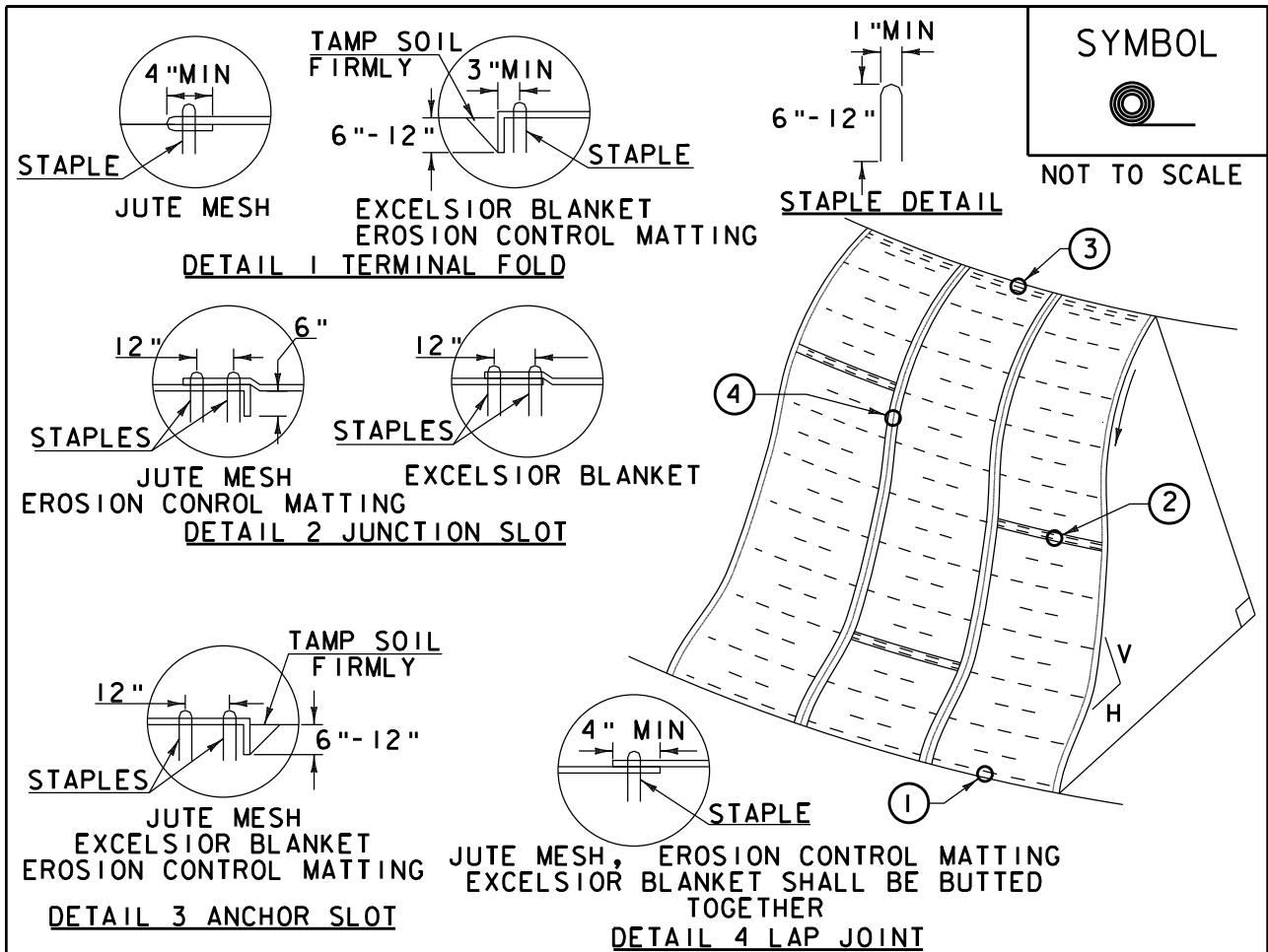

1. APPLY TO SLOPES GREATER THAN 3H:1V OR WHERE NECESSARY TO AID IN ESTABLISHING VEGETATION.
2. APPLY FERTILIZER, LIME SEED PRIOR TO PLACING MATTING.
3. STAPLES ARE TO BE PLACED ALTERNATELY, IN COLUMNS APPROXIMATELY 2' APART AND IN ROWS APPROXIMATELY 3' APART. APPROXIMATELY 175 STAPLES ARE REQUIRED PER 4' X 225' ROLL OF MATERIAL AND 125 STAPLES ARE REQUIRED PER 4' X 150' ROLL OF MATERIAL.
4. DISTURBED AREAS SHALL BE SMOOTHLY GRADED. EROSION CONTROL MATERIAL SHALL BE PLACED LOOSELY OVER GROUND SURFACE. DO NOT STRETCH.
5. ALL TERMINAL ENDS AND TRANSVERSE LAPS SHALL BE STAPLED AT APPROXIMATELY 12" INTERVALS.

ADAPTED FROM DETAILS PROVIDED BY: NEW YORK STATE DEC  
 ORIGINALLY DEVELOPED BY USDA-NRCS  
 VERMONT DEPARTMENT OF ENVIRONMENTAL CONSERVATION

ROLLED EROSION CONTROL PRODUCT (RECP) SIDE SLOPE

**NOTES:**  
 REFER TO "THE VERMONT STANDARDS & SPECIFICATIONS FOR EROSION PREVENTION & SEDIMENT CONTROL -2006- " FROM THE VT AGENCY OF NATURAL RESOURCES FOR ADDITIONAL GUIDANCE.  
 THIS WORK SHALL BE PERFORMED IN ACCORDANCE WITH SECTION 653 AND AS SHOWN IN THE PLANS FOR TEMPORARY EROSION MATTING (PAY ITEM 653.20) OR PERMANENT EROSION MATTING (PAY ITEM 653.21).

REVISIONS	
APRIL 16, 2007	JMF
JANUARY 13, 2009	WHF

SYMBOL

FR

NOT TO SCALE

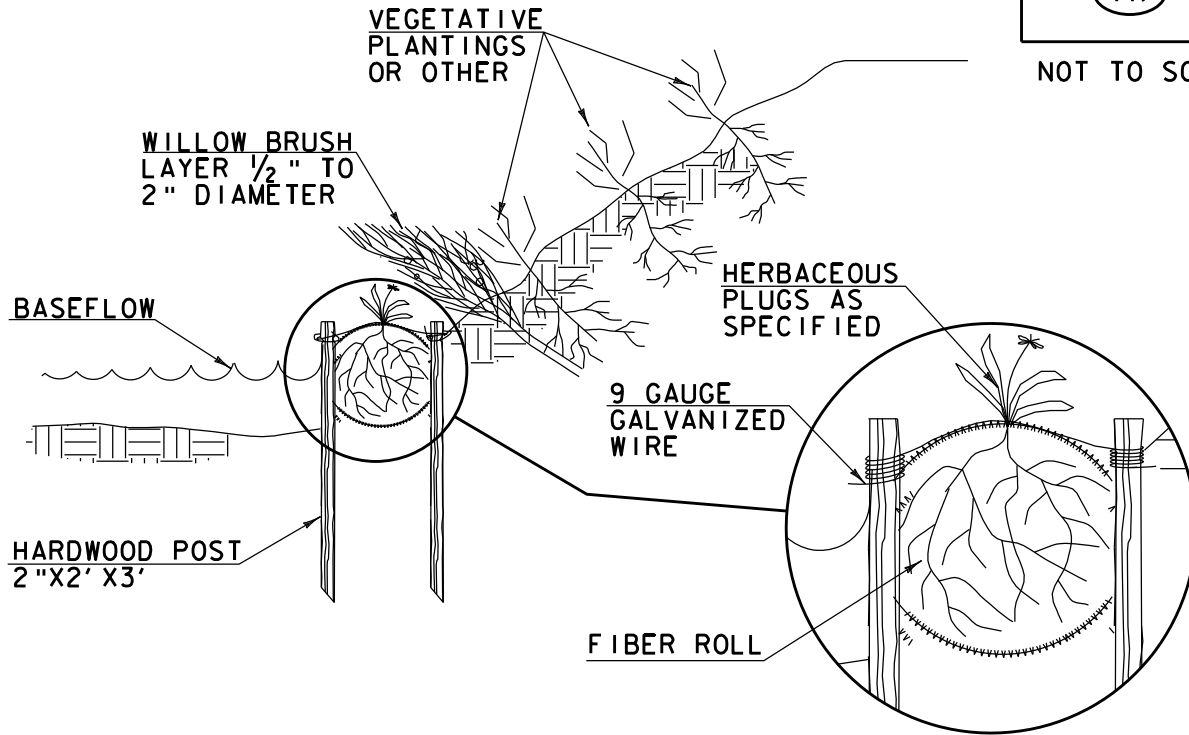

CONSTRUCTION SPECIFICATIONS

1. EXCAVATE A SHALLOW TRENCH SLIGHTLY BELOW BASEFLOW OR A 4" TRENCH ON SLOPE CONTOURS
2. PLACE THE ROLL IN THE TRENCH AND ANCHOR WITH 2"X2" POSTS PLACED ON BOTH SIDES OF THE ROLL AND SPACED Laterally ON 2' TO 4' CENTERS. TRIM THE TOP OF THE POSTS EVEN WITH THE EDGE OF THE ROLL, IF NECESSARY.
3. NOTCH THE POSTS AND TIE TOGETHER, ACROSS THE ROLL, WITH 9 GAUGE GALVANIZED WIRE OR 1/8" DIAMETER BRAIDED NYLON ROPE.
4. PLACE SOIL EXCAVATED FROM THE TRENCH BEHIND THE ROLL AND HAND TAMP. PLANT WITH SUITABLE HERBACEOUS OR WOODY VEGETATION AS SPECIFIED ELSEWHERE IN THE CONTRACT DOCUMENTS. VEGETATION SHALL BE PLACED IMMEDIATELY ADJACENT TO THE ROLL TO PROMOTE ROOT GROWTH INTO THE FIBER. HERBACEOUS VEGETATION, IF SPECIFIED, SHALL BE PLANTED INTO THE FIBER ROLL.

ADAPTED FROM DETAILS PROVIDED BY: NEW YORK STATE DEC  
 ORIGINALLY DEVELOPED BY USDA-NRCS  
 VERMONT DEPARTMENT OF ENVIRONMENTAL CONSERVATION

FIBER ROLL  
 (EROSION LOG)

NOTES:

REFER TO "THE VERMONT STANDARDS & SPECIFICATIONS FOR EROSION PREVENTION & SEDIMENT CONTROL -2006- "FROM THE VT AGENCY OF NATURAL RESOURCES FOR ADDITIONAL GUIDANCE.

THIS WORK SHALL BE PERFORMED IN ACCORDANCE WITH SECTION 653 FOR EROSION LOG (PAY ITEM 653.60)

REVISIONS

MARCH 21, 2008	WHF
JANUARY 13, 2009	WHF

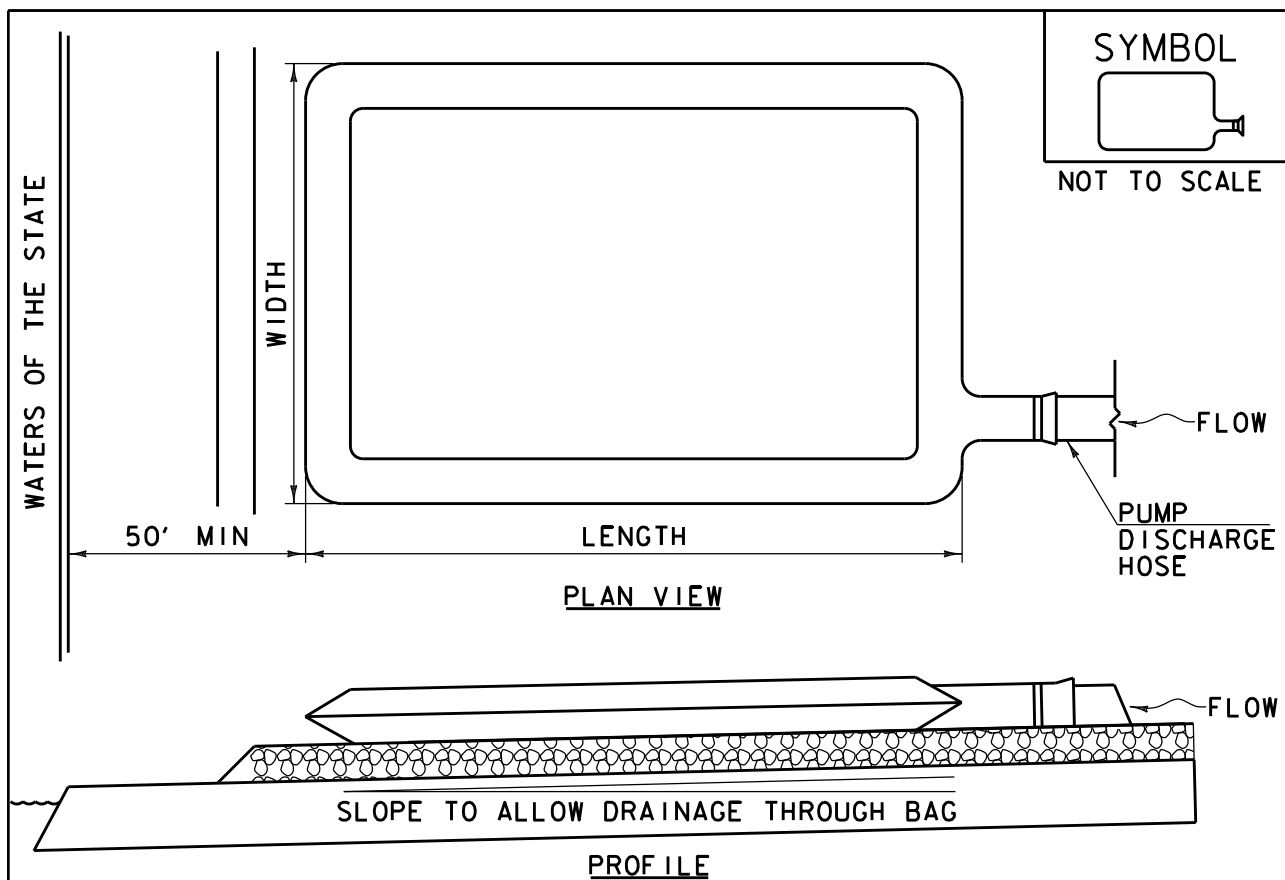

CONSTRUCTION SPECIFICATIONS

1. THE PRIMARY PURPOSE OF FILTER BAG IS TO RETAIN SILT, SAND, AND FINES DURING DEWATERING OPERATIONS.
2. FILTER BAGS SHALL BE INSTALLED ON A VEGETATED SLOPE GRADED TO ALLOW INCOMING WATER TO FLOW THROUGH THE BAG.
3. FILTER BAGS MAY ALSO BE PLACED ON COARSE AGGREGATE, STONE, OR HAYBALES TO INCREASE FILTRATION EFFICIENCY.
4. FILTER BAGS SHALL BE LOCATED A MINIMUM OF 50' FROM WATERS OF THE STATE UNLESS OTHERWISE APPROVED BY THE ENGINEER.
5. THE NECK OF THE FILTER BAG SHALL BE STRAPPED TIGHTLY TO THE DISCHARGE HOSE.
6. A FILTER BAG IS FULL WHEN IT NO LONGER CAN EFFICIENTLY FILTER SEDIMENT OR ALLOW WATER TO PASS AT A REASONABLE RATE.
7. FILTER BAG SHALL BE DISPOSED OF AS APPROVED IN THE EPSC PLAN OR AS DIRECTED BY THE ENGINEER.

FILTER BAG

NOTES:

REFER TO "THE VERMONT STANDARDS & SPECIFICATIONS FOR EROSION PREVENTION & SEDIMENT CONTROL -2006- " FROM THE VT AGENCY OF NATURAL RESOURCES FOR ADDITIONAL GUIDANCE.

THIS WORK SHALL BE PERFORMED IN ACCORDANCE WITH SECTION 653 FOR FILTER BAG (PAY ITEM 653.45) AND AS SPECIFIED IN THE CONTRACT.

REVISIONS

MARCH 24, 2008	WHF
JANUARY 13, 2009	WHF

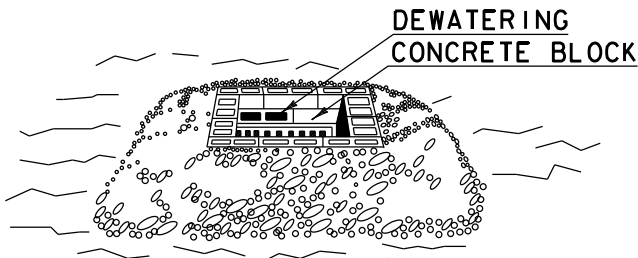

SYMBOL



NOT TO SCALE

STONE & BLOCK PLAN VIEW

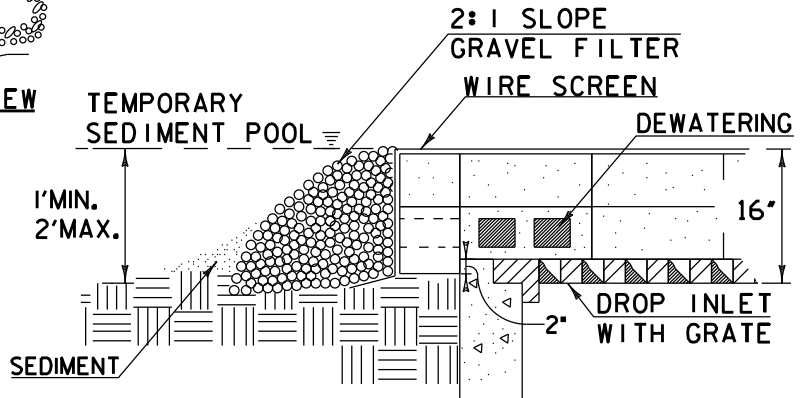

STONE & BLOCK DETAIL

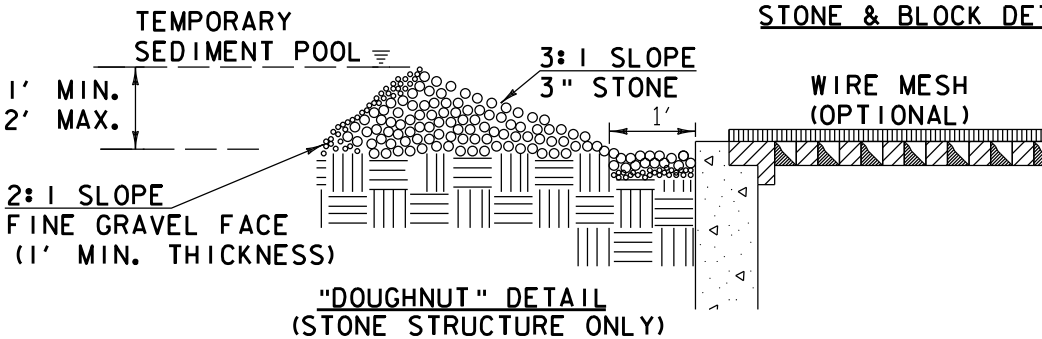

CONSTRUCTION SPECIFICATIONS

1. LAY ONE BLOCK ON EACH SIDE OF THE STRUCTURE ON ITS SIDE FOR DEWATERING. FOUNDATION SHALL BE 2" MINIMUM BELOW REST OF INLET AND BLOCKS SHALL BE PLACED AGAINST INLET FOR SUPPORT.
2. HARDWARE CLOTH OR 1/2" WIRE MESH SHALL BE PLACED OVER BLOCK OPENINGS TO SUPPORT STONE.
3. USE CLEAN STONE OR GRAVEL 1/2" - 3/4" IN DIAMETER PLACED 2" BELOW TOP OF THE BLOCK ON A 2:1 SLOPE OR FLATTER.
4. FOR STONE STRUCTURES ONLY, A 1' THICK LAYER OF THE FILTER STONE WILL BE PLACED AGAINST THE 3" STONE AS SHOWN ON THE DRAWINGS.
5. MAXIMUM DRAINAGE AREA 1 ACRE

ADAPTED FROM DETAILS PROVIDED BY: NEW YORK STATE DEC  
ORIGINALLY DEVELOPED BY USDA-NRCS  
VERMONT DEPARTMENT OF ENVIRONMENTAL CONSERVATION

STONE & BLOCK DROP  
INLET PROTECTION

NOTES:

REFER TO "THE VERMONT STANDARDS & SPECIFICATIONS FOR EROSION PREVENTION & SEDIMENT CONTROL -2006-" FROM THE VT AGENCY OF NATURAL RESOURCES FOR ADDITIONAL GUIDANCE.

THIS WORK SHALL BE PERFORMED IN ACCORDANCE WITH SECTION 653 FOR INLET PROTECTION DEVICE, TYPE 1(PAY ITEM 653.40).

REVISIONS

MARCH 6, 2008	WHF
JANUARY 13, 2009	WHF

SYMBOL



NOT TO SCALE

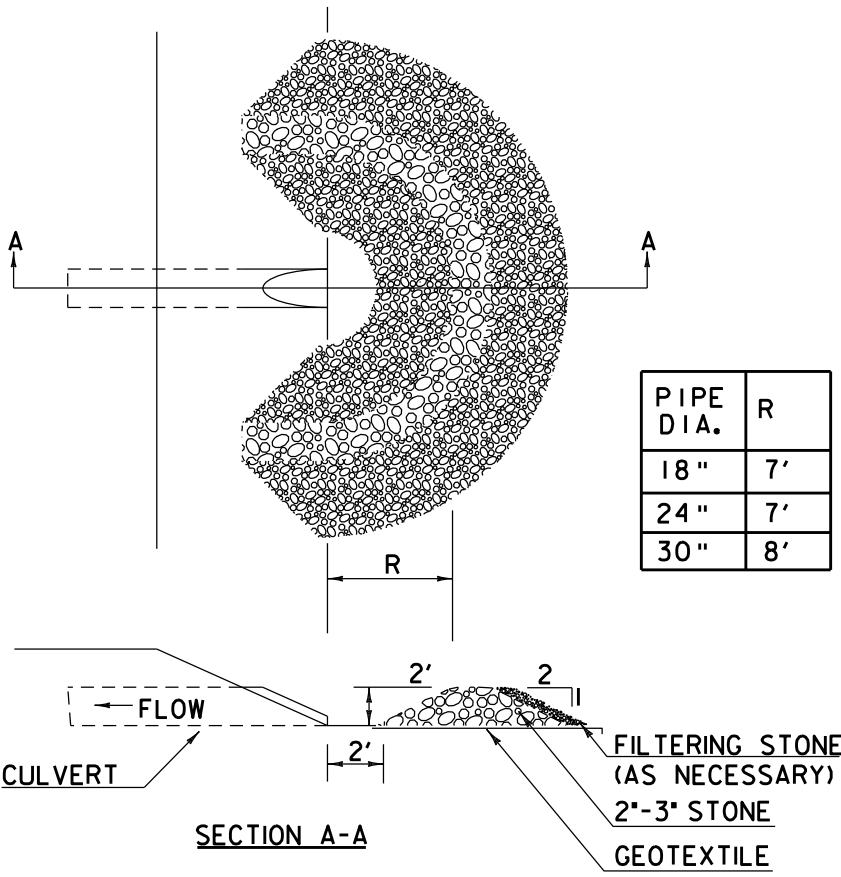

CONSTRUCTION SPECIFICATIONS

1. USE 2" TO 3" STONE. FILTERING STONE SHALL BE 3/4".
2. PLACE STONE OVER GEOTEXTILE.
3. ONCE THE AREAS UPSTREAM FROM THE CHECK DAM ARE STABILIZED WITH VEGETATION, THE SEDIMENT TRAPPED BEHIND THE DAM SHALL BE DISPOSED OF IN AN APPROVED WASTE AREA.
4. THE CHECK DAM(S) SHALL BE FLATTENED AND GRADED IN A MANNER WHICH PROTECTS THE AREA FROM EROSION AND CHANNEL BLOCKAGE . (GEOTEXTILE MUST BE REMOVED).
5. THE GEOTEXTILE MUST BE DISPOSED OF APPROPRIATELY.
6. THE AREA CONTRIBUTING TO THE CHECK DAM SHALL NOT EXCEED 4 ACRES.

ADAPTED FROM DETAILS PROVIDED BY: ILLINOIS USDA-NRCS  
 ORIGINALLY DEVELOPED BY USDA-NRCS

PIPE INLET  
 PROTECTION

REVISIONS	
MARCH 6, 2008	WHF
JANUARY 13, 2009	WHF

THIS WORK SHALL BE PERFORMED IN ACCORDANCE WITH SECTION 653 FOR INLET PROTECTION DEVICE, TYPE I (PAY ITEM 653.40).

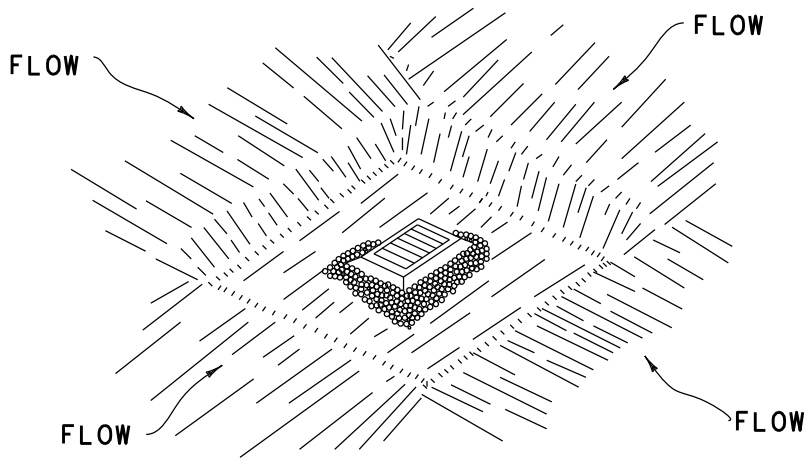

SYMBOL

NOT TO SCALE

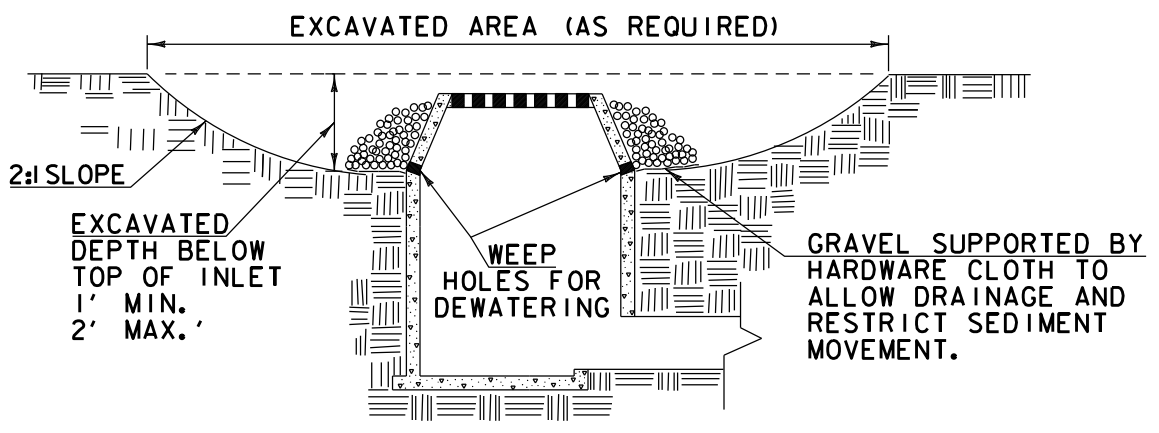

CONSTRUCTION SPECIFICATIONS

1. CLEAR THE AREA OF ALL DEBRIS THAT WILL HINDER EXCAVATION.
2. GRADE APPROACH TO THE INLET UNIFORMLY AROUND THE BASIN.
3. WEEP HOLES SHALL BE PROTECTED BY GRAVEL.
4. UPON STABILIZATION OF CONTRIBUTING DRAINAGE AREA, SEAL WEEP HOLES, FILL BASIN WITH STABLE SOIL TO FINAL GRADE, COMPACT IT PROPERLY AND STABILIZE WITH PERMANENT SEEDING.
5. MAXIMUM DRAINAGE AREA 1 ACRE

ADAPTED FROM DETAILS PROVIDED BY: NEW YORK STATE DEC  
 ORIGINALLY DEVELOPED BY USDA-NRCS  
 VERMONT DEPARTMENT OF ENVIRONMENTAL CONSERVATION

EXCAVATED DROP  
 INLET PROTECTION

NOTES:  
 REFER TO "THE VERMONT STANDARDS & SPECIFICATIONS FOR  
 EROSION PREVENTION & SEDIMENT CONTROL -2006-" FROM  
 THE VT AGENCY OF NATURAL RESOURCES FOR ADDITIONAL  
 GUIDANCE.

THIS WORK SHALL BE PERFORMED IN ACCORDANCE WITH  
 SECTION 653 FOR INLET PROTECTION DEVICE, TYPE I(PAY  
 ITEM 653.40).

REVISIONS	
MARCH 6, 2008	WHF
JANUARY 13, 2009	WHF

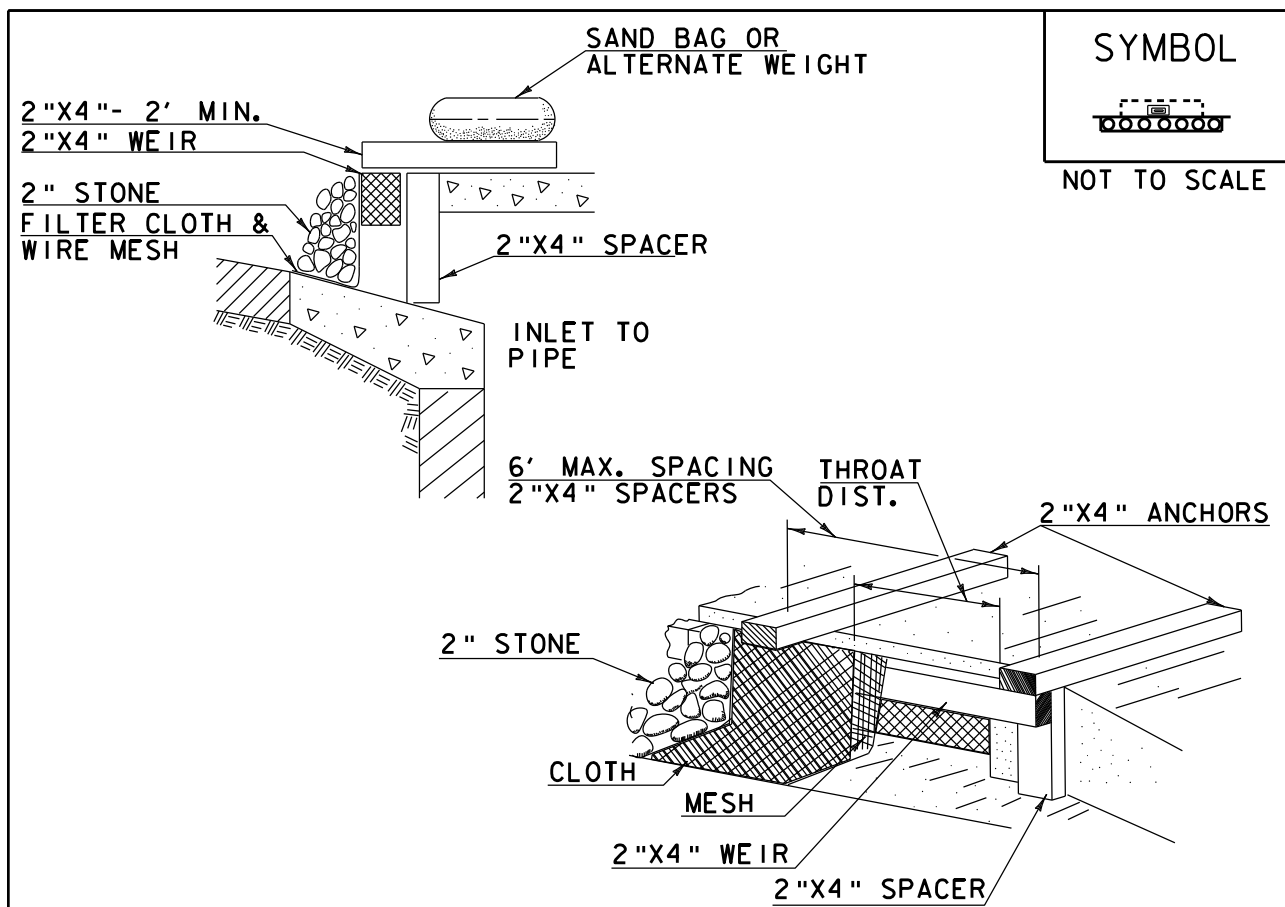

SYMBOL  

NOT TO SCALE

**CONSTRUCTION SPECIFICATIONS**

1. FILTER FABRIC SHALL HAVE AN APPARENT OPENING SIZE OF 40-85.
2. WOODEN FRAME SHALL BE CONSTRUCTED OF 2" x 4" CONSTRUCTION GRADE LUMBER.
3. WIRE MESH ACROSS THROAT SHALL BE A CONTINUOUS PIECE 30" MINIMUM WIDTH WITH A LENGTH 4' LONGER THAN THE THROAT. IT SHALL BE SHAPED AND SECURELY NAILED TO A 2"x 4" WEIR.
4. THE WEIR SHALL BE SECURELY NAILED TO 2"x 4" SPACERS 9" LONG SPACED NO MORE THAN 6' APART.
5. THE ASSEMBLY SHALL BE PLACED AGAINST THE INLET AND SECURED BY 2"x 4" ANCHORS 2' LONG EXTENDING ACROSS THE TOP OF THE INLET AND HELD IN PLACE BY SANDBAGS OR ALTERNATE WEIGHTS.
6. MAXIMUM DRAINAGE AREA 1 ACRE

ADAPTED FROM DETAILS PROVIDED BY: NEW YORK STATE DEC  
 ORIGINALLY DEVELOPED BY USDA-NRCS  
 VERMONT DEPARTMENT OF ENVIRONMENTAL CONSERVATION

**CURB DROP INLET PROTECTION**

NOTES:  
 REFER TO "THE VERMONT STANDARDS & SPECIFICATIONS FOR EROSION PREVENTION & SEDIMENT CONTROL -2006- "FROM THE VT AGENCY OF NATURAL RESOURCES FOR ADDITIONAL GUIDANCE.

THIS WORK SHALL BE PERFORMED IN ACCORDANCE WITH SECTION 653 FOR INLET PROTECTION DEVICE, TYPE 1(PAY ITEM 653.40).

REVISIONS	
MARCH 6, 2008	WHF
JANUARY 13, 2009	WHF

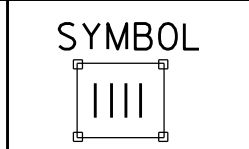
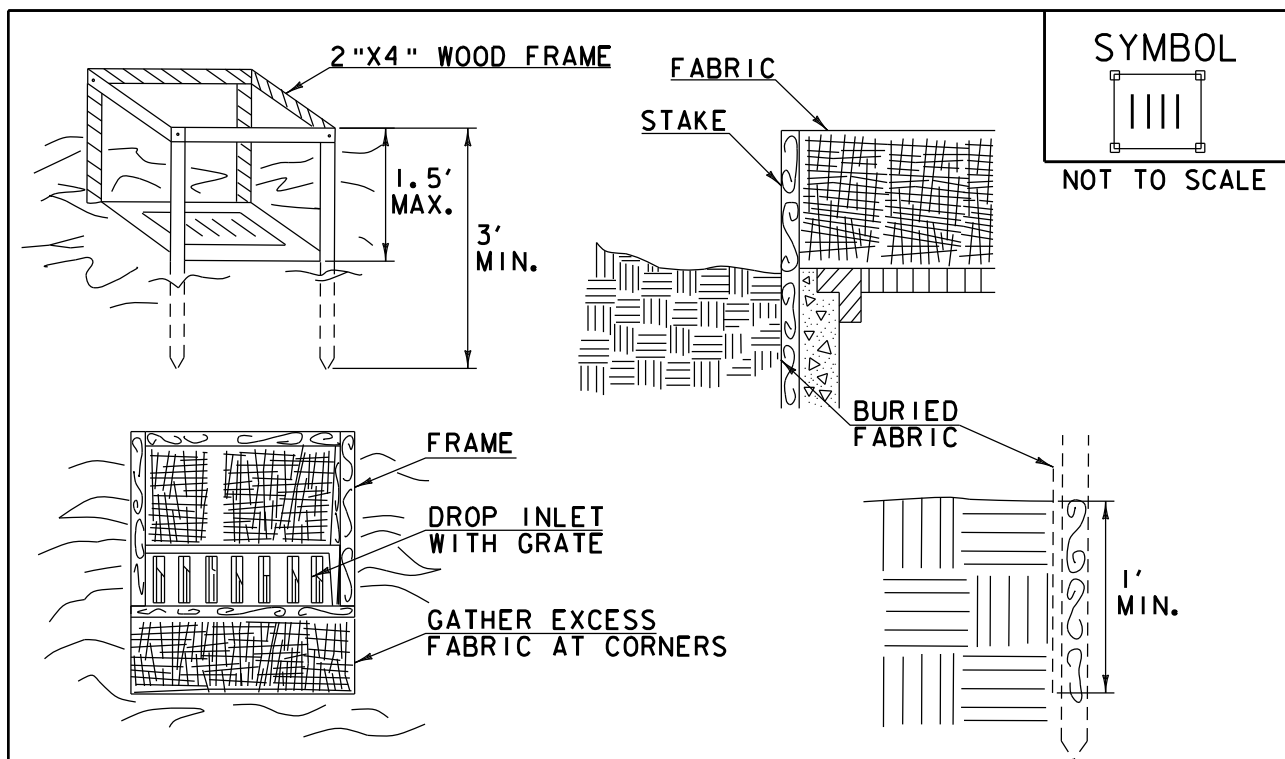

NOT TO SCALE

### CONSTRUCTION SPECIFICATIONS

1. FILTER FABRIC SHALL HAVE AN APPARENT OPENING SIZE OF 40-85. BURLAP MAY BE USED FOR SHORT TERM APPLICATIONS.
2. CUT FABRIC FROM A CONTINUOUS ROLL TO ELIMINATE JOINTS. IF JOINTS ARE NEEDED THEY WILL BE OVERLAPPED TO THE NEXT STAKE.
3. STAKE MATERIALS WILL BE STANDARD 2"x 4" WOOD OR EQUIVALENT METAL WITH A MINIMUM LENGTH OF 3'.
4. SPACE STAKES EVENLY AROUND INLET 3' APART AND DRIVE A MINIMUM 18" DEEP. SPANS GREATER THAN 3' MAY BE BRIDGED WITH THE USE OF WIRE MESH BEHIND THE FILTER FABRIC FOR SUPPORT.
5. FABRIC SHALL BE EMBEDDED 1' MINIMUM BELOW GROUND AND BACKFILLED. IT SHALL BE SECURELY FASTENED TO THE STAKES AND FRAME.
6. A 2" x 4" WOOD FRAME SHALL BE COMPLETED AROUND THE CREST OF THE FABRIC FOR OVER FLOW STABILITY.
7. MAXIMUM DRAINAGE AREA 1 ACRE

ADAPTED FROM DETAILS PROVIDED BY: NEW YORK STATE DEC  
 ORIGINALLY DEVELOPED BY USDA-NRCS  
 VERMONT DEPARTMENT OF ENVIRONMENTAL CONSERVATION

### FILTER FABRIC DROP INLET PROTECTION

**NOTES:**

REFER TO "THE VERMONT STANDARDS & SPECIFICATIONS FOR EROSION PREVENTION & SEDIMENT CONTROL -2006- " FROM THE VT AGENCY OF NATURAL RESOURCES FOR ADDITIONAL GUIDANCE.

THIS WORK SHALL BE PERFORMED IN ACCORDANCE WITH SECTION 653 FOR INLET PROTECTION DEVICE, TYPE I(PAY ITEM 653.40).

**REVISIONS**

MARCH 7, 2008	WHF
JANUARY 13, 2009	WHF

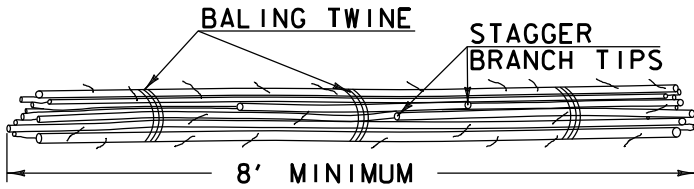

FASCINE BUNDLE DETAIL

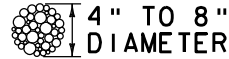

SYMBOL

LF

NOT TO SCALE

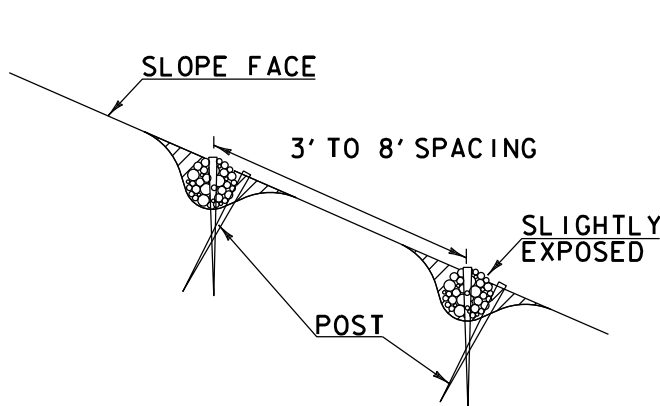

SLOPE CROSS SECTION

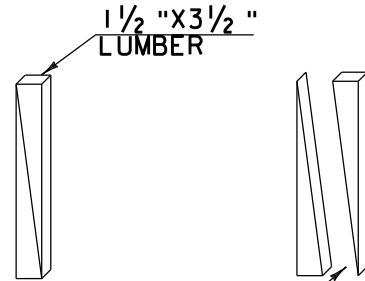

SAW 1 1/2 "X3 1/2 "  
DIAGONALLY TO  
PRODUCE TWO  
POSTS

POST DETAIL

CONSTRUCTION SPECIFICATIONS

1. LIVE FASCINES SHALL BE OBTAINED FROM SOURCES APPROVED BY THE ENGINEER. THEY SHALL BE PREPARED FROM FRESHLY CUT DORMANT PLANTS AND INSTALLED WITHIN 8 HOURS OF THE TIME THE MATERIAL IS HARVESTED, UNLESS PROPERLY STORED.
2. LIVE FASCINES SHALL BE PLACED AS INDICATED IN THE CONTRACT DOCUMENTS.
3. BEGINNING AT THE BASE OF THE SLOPE, A TRENCH SHALL BE DUG LARGE ENOUGH TO CONTAIN THE LIVE FASCINES. THE LIVE FASCINES SHALL BE PLACED IN THE TRENCH. WHERE ENDS MEET IN THE TRENCH, THE FASCINES SHALL OVERLAP 18".
4. WOOD POSTS SHALL BE INSTALLED FLUSH TO THE TOP OF THE FASCINE EVERY 18" ALONG THE LENGTH OF THE BUNDLES AS SHOWN ON THE CROSS SECTIONS. WHERE SPECIFIED LIVE STAKES MAY BE USED IN PLACE OF POSTS.
5. THE TRENCH SHALL BE BACKFILLED WITH MOIST SOIL AND HAND TAMPED. THE TOP OF THE FASCINE SHALL BE SLIGHTLY EXPOSED WHEN THE INSTALLATION IS COMPLETE AS SHOWN ON THE CROSS SECTION.
6. SEED OR OTHER EROSION CONTROL MATERIAL SHALL BE USED BETWEEN THE FASCINE ROWS, AS SPECIFIED IN THE CONTRACT DOCUMENTS.

ADAPTED FROM DETAILS PROVIDED BY: NEW YORK STATE DEC  
ORIGINALLY DEVELOPED BY USDA-NRCS  
VERMONT DEPARTMENT OF ENVIRONMENTAL CONSERVATION

LIVE FASCINE

NOTES:

REFER TO "THE VERMONT STANDARDS & SPECIFICATIONS FOR EROSION PREVENTION & SEDIMENT CONTROL -2006- " FROM THE VT AGENCY OF NATURAL RESOURCES FOR ADDITIONAL GUIDANCE.

THIS WORK SHALL BE PERFORMED IN ACCORDANCE WITH SECTION 653 FOR LIVE FASCINE (PAY ITEM 653.65).

REVISIONS

MARCH 7, 2008	WHF
DECEMBER 9, 2008	WHF
JANUARY 13, 2009	WHF

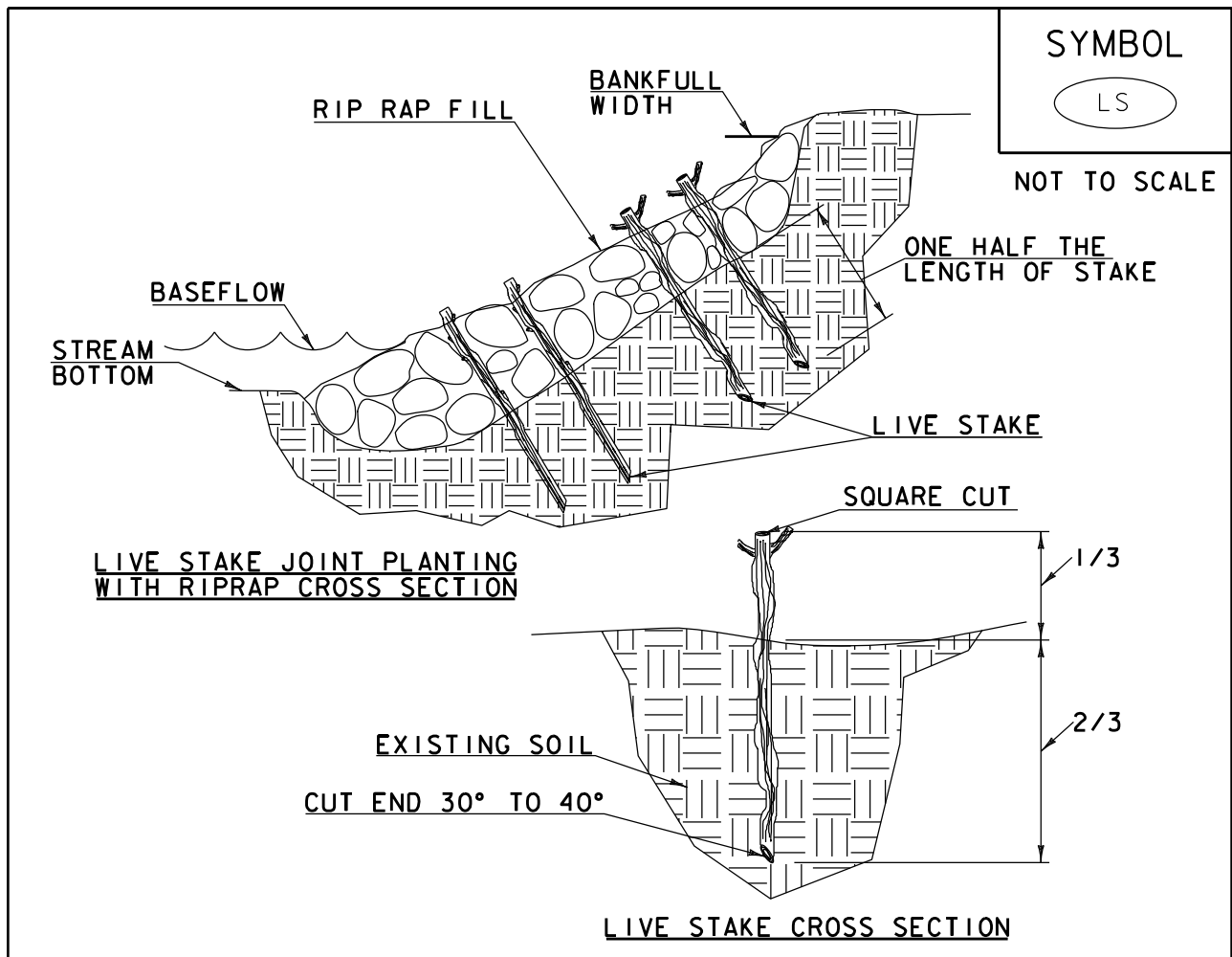

CONSTRUCTION SPECIFICATIONS

1. LENGTH OF STAKE DEPENDS UPON APPLICATION
2. LIVE STAKES SHALL BE CUT TO A POINT ON THE BASAL END FOR INSERTION IN THE GROUND.
3. A DIBBLE, IRON BAR, OR SIMILAR TOOL SHALL BE USED TO MAKE A PILOT HOLE PRIOR TO INSERTING STAKE IN GROUND.
4. A MINIMUM OF 2" TO 4" AS WELL AS 2 LIVE BUDS SHALL BE EXPOSED ABOVE THE GROUND OR RIP RAP.
5. TAMP SOIL AROUND STAKE.
6. CARE SHALL BE TAKEN TO MINIMIZE DAMAGE TO STAKE. ANY DAMAGE SHALL BE TRIMMED BACK TO AN UNDAMAGED CONDITION.

ADAPTED FROM DETAILS PROVIDED BY: NEW YORK STATE  
 DECORIGINALLY DEVELOPED BY USDA-NRCSVERMONT DEPARTMENT  
 OF ENVIRONMENTAL CONSERVATION

LIVE STAKE

NOTES:  
 REFER TO "THE VERMONT STANDARDS & SPECIFICATIONS FOR  
 EROSION PREVENTION & SEDIMENT CONTROL -2006- " FROM  
 THE VT AGENCY OF NATURAL RESOURCES FOR ADDITIONAL  
 GUIDANCE.

REVISIONS	
MARCH 21, 2008	WHF
JANUARY 27, 2009	WHF

THIS WORK SHALL BE PERFORMED IN ACCORDANCE WITH  
 SECTION 653 FOR LIVE STAKE (PAY ITEM 653.70)

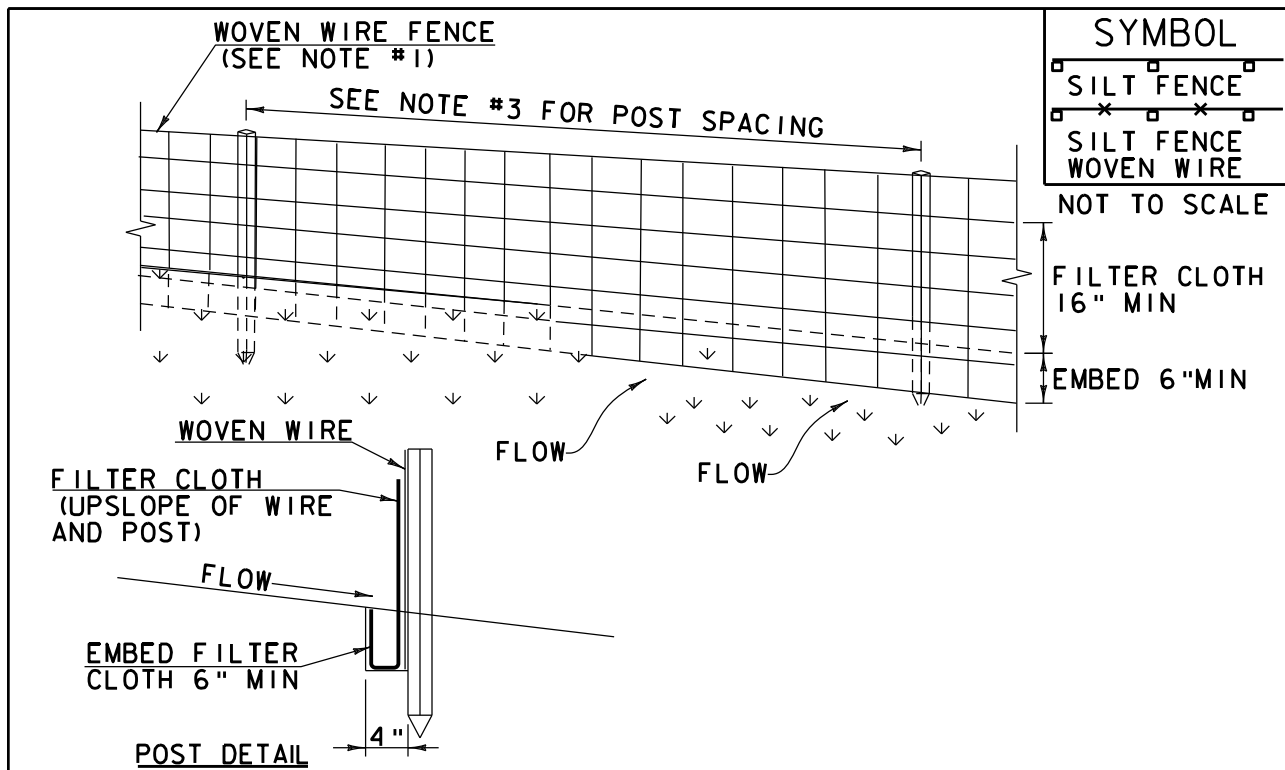

SYMBOL	
□	SILT FENCE
□	SILT FENCE WOVEN WIRE

NOT TO SCALE

FILTER CLOTH  
16" MIN

EMBED 6" MIN

### CONSTRUCTION SPECIFICATIONS

1. WOVEN WIRE REINFORCED FENCE IS REQUIRED WITHIN 100' UPSLOPE OF RECEIVING WATERS WHEN THE PROJECT FALLS UNDER A CONSTRUCTION STORMWATER PERMIT. WOVEN WIRE SHALL BE A MIN. 14 GAUGE WITH A 6" MAX. MESH OPENING.
2. FILTER CLOTH SHALL BE EITHER FILTER X, MIRAF1100X, STABILINKA T140N OR APPROVED EQUIVALENT.
3. POST SPACING FOR WIRE-BACKED FENCE SHALL BE 10' MAXIMUM. FOR FILTER-CLOTH FENCE, WHEN ELONGATION IS >50%, POST SPACING SHALL NOT EXCEED 4' AND WHEN ELONGATION IS <50%, POST SPACING SHALL NOT EXCEED 6'.
4. WOVEN WIRE FENCE IS TO BE FASTENED SECURELY TO FENCE POSTS WITH WIRE TIES. FILTER CLOTH IS TO BE FASTENED SECURELY TO WOVEN WIRE FENCE WITH TIES SPACED EVERY 24" AT TOP AND MID SECTION.
5. WHEN TWO SECTIONS OF FILTER CLOTH ADJOIN EACH OTHER THEY SHALL BE OVER-LAPPED BY 6" AND FOLDED.
6. MAINTENANCE SHALL BE PERFORMED AS NEEDED AND MATERIAL REMOVED WHEN SEDIMENT REACHES HALF OF FABRIC HEIGHT.

ADAPTED FROM DETAILS PROVIDED BY: NEW YORK STATE DEC  
ORIGINALLY DEVELOPED BY USDA-NRCS  
VERMONT DEPARTMENT OF ENVIRONMENTAL CONSERVATION

SILT FENCE

#### NOTES:

REFER TO "THE VERMONT STANDARDS & SPECIFICATIONS FOR EROSION PREVENTION & SEDIMENT CONTROL -2006- "FROM THE VT AGENCY OF NATURAL RESOURCES FOR ADDITIONAL GUIDANCE.

THIS WORK SHALL BE PERFORMED IN ACCORDANCE WITH SECTION 649 AND AS SHOWN IN THE PLANS FOR GEOTEXTILE FOR SILT FENCE (PAY ITEM 649.5) OR GEOTEXTILE FOR SILT FENCE, WOVEN WIRE REINFORCED (PAY ITEM 649.515).

#### REVISIONS

MARCH 21, 2008	WHF
DECEMBER 11, 2008	WHF
JANUARY 13, 2009	WHF

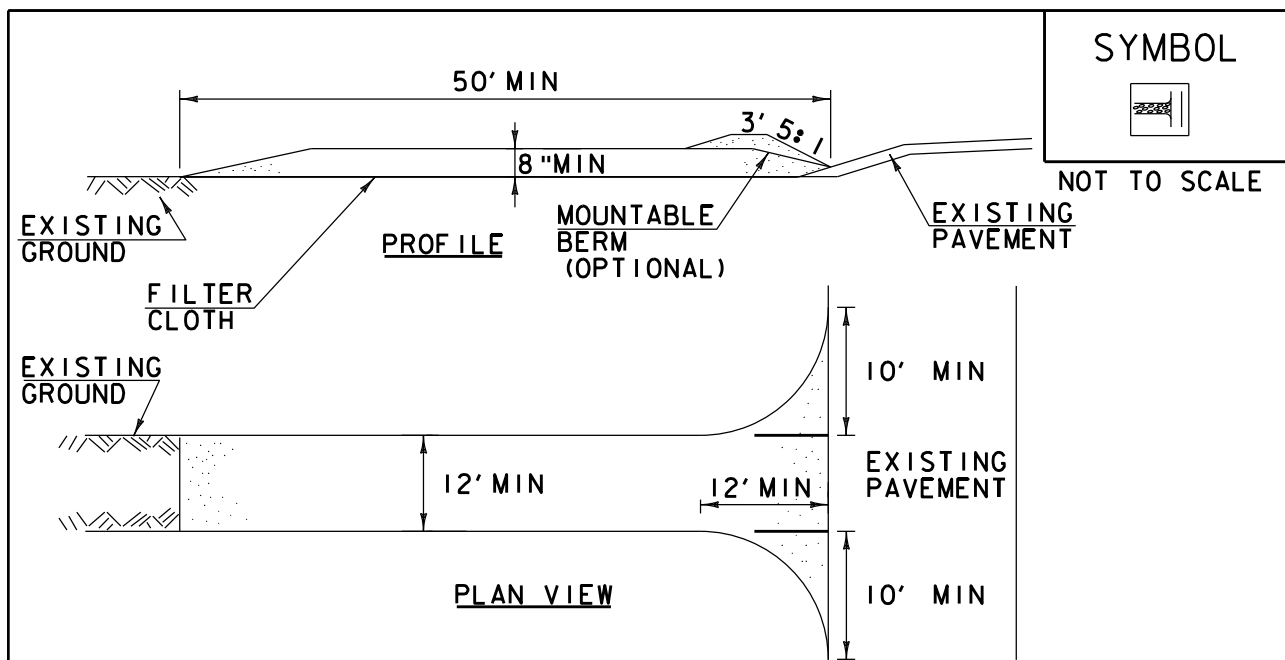

1. STONE SIZE- USE 1-4" STONE , RECLAIMED OR RECYCLED CONCRETE EQUIVALENT.
2. LENGTH- NOT LESS THAN 50' (EXCEPT ON A SINGLE RESIDENCE LOT WHERE A 30' MINIMUM LENGTH APPLIES).
3. THICKNESS- NOT LESS THAN 8".
4. WIDTH- 12' MINIMUM, BUT NOT LESS THAN THE FULL WIDTH AT POINTS WHERE INGRESS OR EGRESS OCCURS. 24' IF SINGLE ENTRANCE TO SITE.
5. GEOTEXTILE MUST BE PLACED OVER THE ENTIRE AREA PRIOR TO PLACING STONE.
6. SURFACE WATER- ALL SURFACE WATER FLOWING OR DIVERTED TOWARD CONSTRUCTION ENTRANCES SHALL BE PIPED BENEATH THE ENTRANCE. IF PIPING IS IMPRACTICAL , A MOUNTABLE BERM WITH 5:1 SLOPES WILL BE PERMITTED.
7. MAINTENANCE- THE ENTRANCE SHALL BE MAINTAINED IN A CONDITION WHICH WILL PREVENT TRACKING OR FLOWING OF SEDIMENT ONTO PUBLIC RIGHTS-OF-WAY, ALL SEDIMENT SPILLED, DROPPED, WASHED OR TRACKED ONTO PUBLIC RIGHTS-OF-WAY MUST BE REMOVED IMMEDIATELY.
8. WHEN WASHING IS REQUIRED, IT SHALL BE DONE ON AN AREA STABILIZED WITH STONE AND WHICH DRAINS INTO AN APPROVED SEDIMENT TRAPPING DEVICE.
9. PERIODIC INSPECTION AND NEEDED MAINTENANCE SHALL BE PROVIDED ACCORDING TO PERMIT REQUIREMENTS.

ADAPTED FROM DETAILS PROVIDED BY: NEW YORK STATE DEC  
 ORIGINALLY DEVELOPED BY USDA-NRCS  
 VERMONT DEPARTMENT OF ENVIRONMENTAL CONSERVATION

**STABILIZED  
 CONSTRUCTION  
 ENTRANCE**

**NOTES:**  
 REFER TO "THE VERMONT STANDARDS & SPECIFICATIONS FOR EROSION PREVENTION & SEDIMENT CONTROL -2006- " FROM THE VT AGENCY OF NATURAL RESOURCES FOR ADDITIONAL GUIDANCE.

THIS WORK SHALL BE PERFORMED IN ACCORDANCE WITH SECTION 653 FOR VEHICLE TRACKING PAD (PAY ITEM 653.35) OR AS SPECIFIED IN THE CONTRACT.

REVISIONS	
MARCH 24, 2008	WHF
JANUARY 13, 2009	WHF

SYMBOL



NOT TO SCALE

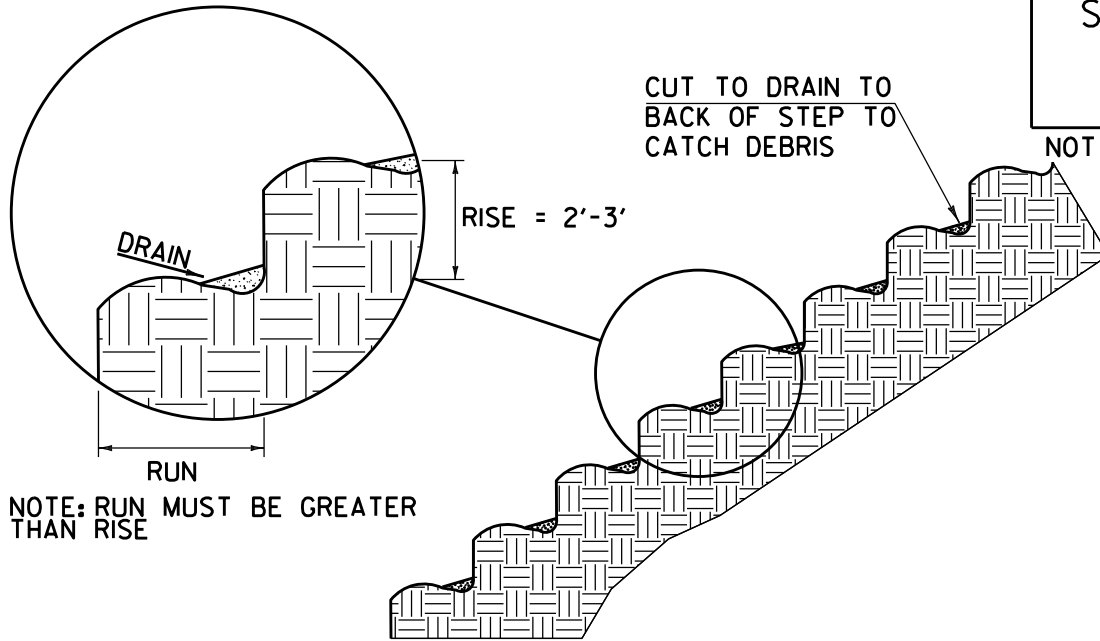

STAIR STEPPING CUT SLOPES

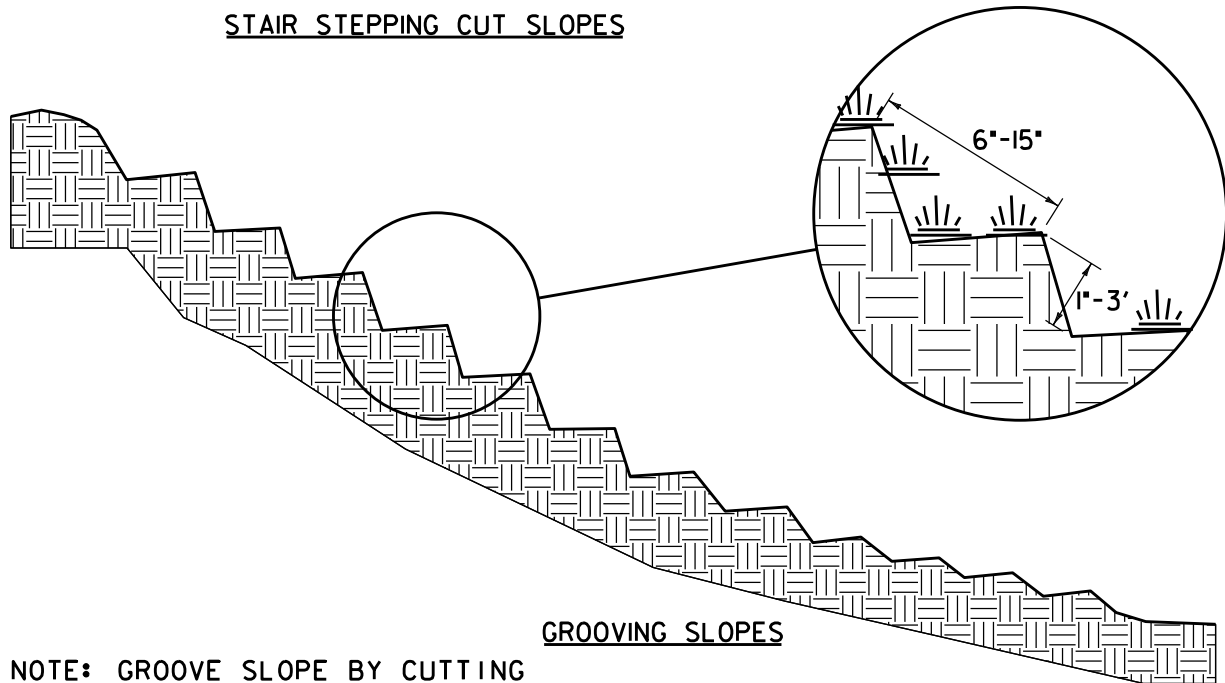

GROOVING SLOPES

NOTE: GROOVE SLOPE BY CUTTING FURROWS ALONG THE CONTOUR. IRREGULARITIES IN THE SOIL SURFACE CATCH RAINWATER AND RETAIN LIME, FERTILIZER AND SEED.

ADAPTED FROM DETAILS PROVIDED BY: NEW YORK STATE DEC  
ORIGINALLY DEVELOPED BY USDA-NRCS  
VERMONT DEPARTMENT OF ENVIRONMENTAL CONSERVATION

SURFACE ROUGHENING

NOTES:  
REFER TO "THE VERMONT STANDARDS & SPECIFICATIONS FOR EROSION PREVENTION & SEDIMENT CONTROL -2006-" FROM THE VT AGENCY OF NATURAL RESOURCES FOR ADDITIONAL GUIDANCE.

THIS WORK SHALL BE CONSIDERED INCIDENTAL TO THE CONTRACT

REVISIONS	
APRIL 1, 2008	WHF
JANUARY 13, 2009	WHF

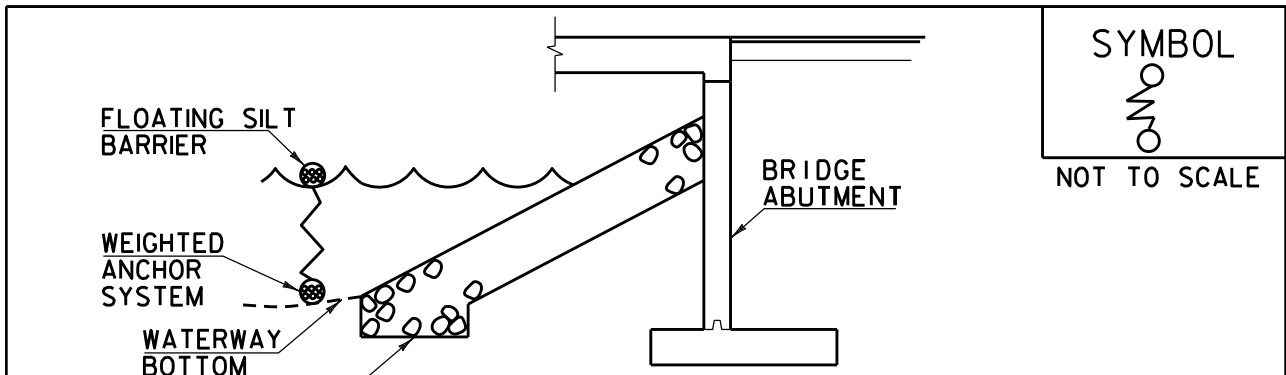

SECTION A-A

NOTE: THIS DRAWING IS A DEPICTION OF A TYPICAL INSTALLATION OF FILTER CURTAIN. IT IN NO WAY DEFINES THE TYPE OR USE OF COFFERDAM IF USED.

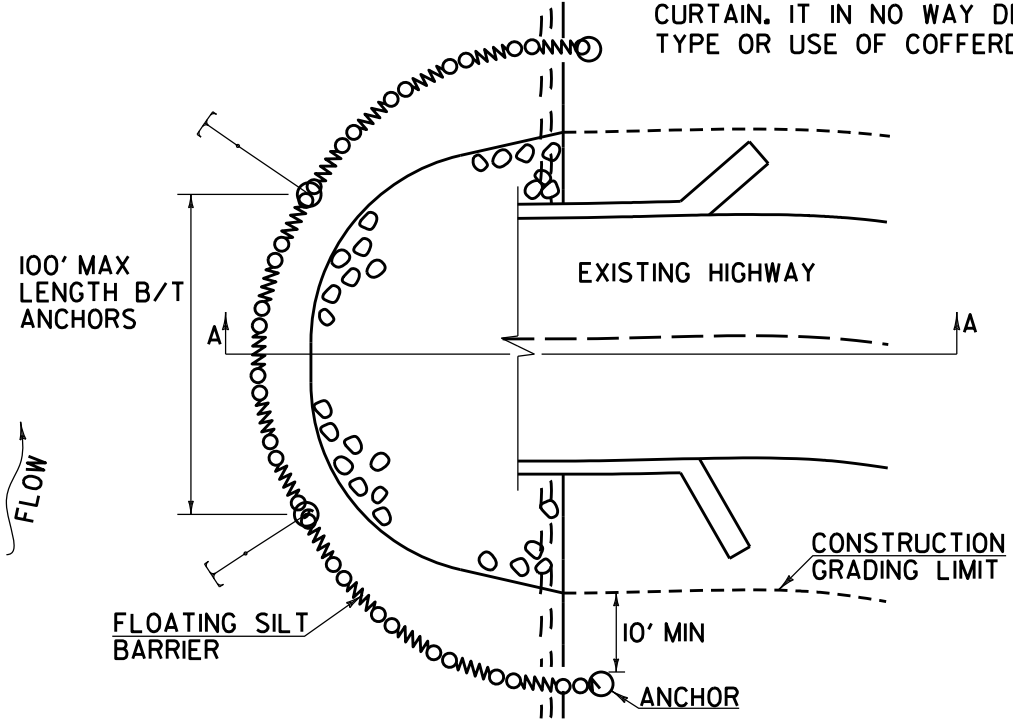

**CONSTRUCTION SPECIFICATIONS**

1. FILTER CURTAIN SHALL NOT BE PLACED ACROSS A FLOWING WATERWAY, OR IN A WATERWAY WITH STREAM VELOCITIES GREATER THAN 1.5 FEET/SECOND.
2. MAXIMUM 100' LENGTH BETWEEN ANCHORS.
3. LAST SECTION SHALL TERMINATE A MINIMUM OF 10' BEYOND LIMIT OF DISTURBANCE.
4. THE WEIGHTED ANCHOR SYSTEM SHALL BE A TYPE WHICH ALLOWS THE CURTAIN TO CONFORM TO THE BOTTOM OF THE WATERWAY.
5. THE CURTAIN SHALL BE REMOVED BY SLOWLY PULLING TOWARD THE SHORE MINIMIZING THE ESCAPE OF SEDIMENTS INTO WATERWAY.

**FILTER CURTAIN**

REVISIONS	
APRIL 1, 2008	WHF
JANUARY 13, 2009	WHF
SEPTEMBER 4, 2009	WHF

THIS WORK SHALL BE PERFORMED IN ACCORDANCE WITH SECTION 649 FOR GEOTEXTILE FOR FILTER CURTAIN (PAY ITEM 649.6I).

BARRIER FENCE (LINE STYLE)  
653.50

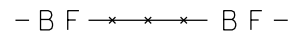

BRUSH LAYER  
653.75, DETAIL



CHECK DAM (LINE STYLE)  
653.25, DETAIL

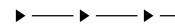

COFFERDAM (LINE STYLE)  
208.40



CURB DROP INLET PROTECTION  
653.40, DETAIL



DUST CONTROL  
609.10 & 15



PIPE INLET PROTECTION  
653.40, DETAIL



EXCAVATED DROP INLET PROTECTION  
653.40, DETAIL



FIBER ROLL (EROSION LOG)  
653.60, DETAIL



FILTER BAG  
653.45, DETAIL



FILTER FABRIC DROP INLET PROTECTION  
653.40, DETAIL



LIVE CUTTINGS/LIVE STAKES PLANTING  
653.70, DETAIL



LIVE FASCINE  
653.65, DETAIL



PROJECT DEMARCATION FENCE (LINE STYLE) -PDF-----PDF-  
653.55



ROLLED EROSION CONTROL PRODUCT (RECP)  
653.20 (TEMP. EROSION MATTING)



SEDIMENT BASIN  
INCIDENTAL TO COFFERDAM 208.40



SILT FENCE(LINE STYLE)  
649.5I, DETAIL



SILT FENCE WOVEN WIRE(LINE STYLE)  
649.5I5, DETAIL



STABILIZED CONSTRUCTION ENTRANCE  
653.35, DETAIL, VEHICLE TRACKING PAD



STONE & BLOCK DROP INLET PROTECTION  
653.40, DETAIL



SURFACE ROUGHENING  
INCIDENTAL TO CONTRACT



TURBIDITY CURTAIN  
649.6I, DETAIL, FILTER CURTAIN

